

EtherSens user manual V2.30 English



User manual compatible with EtherSens firmware V1.49 or higher!

© by PI 2015 - 2024

Content

1 General.....	8
1.1 About the manual.....	8
2 System requirements.....	9
2.1 Software.....	9
2.2 Hardware.....	9
3 Commissioning.....	10
3.1 WLAN communication.....	10
3.2 LAN communication.....	11
3.3 User interaction.....	11
3.4 Web server.....	12
4 Web server.....	13
4.1 Menu item current and history.....	13
4.2 Menu item fault messages.....	18
4.3 Menu item system.....	20
4.3.1 Menu item general.....	23
4.3.2 Menu item network and WiFi.....	28
4.3.3 Menu item USB.....	32
4.3.4 Menu item serial interface.....	34
4.3.5 Menu item date and time.....	35
4.3.6 Menu item e-mail.....	36
4.3.7 Menu item storage.....	40
4.3.7.1 Menu item settings.....	40
4.3.7.2 Menu item file manager.....	44
4.4 Menu item process.....	46
4.4.1 Menu item devices.....	48
4.4.1.1 Menu item client.....	48
4.4.1.2 Menu item server.....	51
4.4.1.3 Menu item couplings.....	52
4.4.2 Menu item process values.....	54

4.4.2.1	Advanced settings for Energy.....	56
4.4.2.2	Advanced settings for Analog-In (HW 1.0).....	57
4.4.2.3	Advanced settings for Analog-In (HW 1.1).....	58
4.4.2.4	Advanced settings for Analog-Out.....	59
4.4.2.5	Advanced settings for Digital-IO.....	59
4.4.2.6	Advanced settings for LED segment.....	59
4.4.2.7	Advanced settings for accelerometer.....	60
4.4.2.8	Advanced settings for light sensors.....	61
4.4.2.9	Advanced settings for temperature sensor.....	61
4.4.2.10	Advanced settings for PLC values.....	61
4.4.2.11	Advanced settings for EtherSens values.....	63
4.4.2.12	Advanced settings for Modbus values.....	63
4.4.2.13	Advanced settings for system values.....	64
4.4.2.14	Advanced settings for internal values.....	67
4.4.2.15	Calibration for Energy.....	68
4.4.2.16	Calibration for accelerometer.....	68
4.4.2.17	Calibration (general).....	69
4.4.2.18	Page expert mode.....	70
4.4.3	Menu item calculations.....	76
4.4.4	Menu item limit values.....	79
4.4.5	Menu item PLC messages.....	84
4.4.6	Menu item message settings.....	87
4.4.7	Menu item DB backup/restore.....	88
4.5	Menu item log in.....	90
4.6	Menu item firmware update.....	92
4.7	Menu item change password.....	93
4.8	Menu item factory reset.....	95
4.9	Menu item reboot.....	96
4.10	Menu item error log.....	97
4.11	Menu item system status.....	97
4.12	Menu item instruments.....	98

4.12.1 Menu item V - A - Hz.....	99
4.12.2 Menu item power.....	99
4.12.3 Menu item energy total.....	100
4.12.4 Menu item energy fundamental.....	100
5 PLC controlled e-mail- and SMS delivery.....	101
5.1 Configuration.....	101
5.2 Structure of flag-word for packet control.....	103
5.3 Structure of flag word for order status.....	105
5.4 Structure of communication-DB.....	107
5.5 Structure of receiver DB.....	108
5.6 Expiration of PLC controlled delivery.....	109
5.7 Expiration of PLC controlled reception.....	111
6 E-mail reception.....	112
6.1 Configuration.....	112
6.2 Expiration of the reception and assignment of e-mails.....	112
7 SMS sending and receiving of process values.....	114
7.1 Configuration.....	114
7.2 SMS sending.....	114
7.3 SMS receiving.....	115
8 Coupling with WinCC.....	117
9 Process server.....	119
9.1 TCP process server.....	119
9.2 SNMP process server.....	121
10 Device couplings.....	123
10.1 PLC socket coupling.....	123
10.1.1 configuration.....	123
10.1.2 procedure.....	123
11 L1 bus communication.....	125
11.1 Bus monitor.....	125
11.2 RFC1006 protocol.....	126

12 Modbus communication.....	129
12.1 Modbus master.....	129
12.1.1 Bus monitor.....	129
12.1.2 RFC1006 protocol.....	130
12.1.3 Process values.....	131
12.2 Modbus slave.....	132
13 EtherSens-Manager.....	133
13.1 Search for devices.....	135
13.2 Configure a device.....	136
13.2.1 Firmware update.....	136
13.2.2 IP configuration.....	137
13.2.3 Device name.....	138
13.2.4 Backup configuration.....	138
13.2.5 Restore configuration.....	138
14 EtherSens CSV converter.....	139
14.1 select files.....	140
14.2 convert files.....	142
15 Hardware.....	144
15.1 LED segment.....	144
16 Usage examples.....	146
16.1 Usage examples EtherSens MONI and Energy.....	146
16.1.1 3-phase consumer.....	146
16.1.2 1-phase consumer.....	147
16.1.3 Consumer without a neutral conductor.....	147
17 Description of each device.....	148
17.1 Description EtherSens MONI.....	148
17.2 Description EtherSens Energy.....	149
17.2.1 Port assignment EtherSens Energy.....	150
17.2.2 Port assignment EtherSens Energy + Analog-IO.....	151
17.2.3 Port assignment EtherSens Energy + Digital-IO.....	152

17.3 Description EtherSens Control.....	153
17.3.1 Port assignment EtherSens Control HW 1.0.....	155
17.3.2 Port assignment EtherSens Control HW 1.1.....	156
17.3.3 Port assignment EtherSens Control Relay (230VAC).....	157
17.3.4 Port assignment EtherSens Control Relay (24VDC).....	158
17.4 Description EtherSens Basic.....	159
17.4.1 Port assignment EtherSens Basic.....	160
18 Description of each option.....	161
18.1 PLC messages with additional text.....	161
19 Connection.....	162
19.1 Connection EtherSens MONI.....	162
19.2 Connection EtherSens Energy.....	163
19.3 Connection EtherSens Control.....	165
19.3.1 Connection EtherSens Control Relay (230VAC).....	165
19.3.2 Connection EtherSens Control Relay (24VDC).....	166
19.4 Connection EtherSens Basic.....	166
20 Technical data.....	167
20.1 Technical data EtherSens MONI.....	167
20.2 Technical data EtherSens Energy.....	168
20.3 Technical data EtherSens Control.....	169
20.4 Technical data EtherSens Basic.....	171
21 Appendix.....	172
21.1 Example codes for TCP process server.....	172
21.1.1 PHP code.....	172
22 Application examples.....	174
22.1 Backup/Restore of data-blocks of S5/S7-PLC.....	174
22.1.1 Connection of the device.....	174
22.1.2 Using a digital IO trigger.....	174
22.1.3 Access to the device.....	174
22.1.4 Enabling the USB connector.....	175

22.1.5 Create PLC connection.....	175
22.1.6 Create PLC trigger.....	176
22.1.7 Create Backup/Restore block.....	176
22.1.8 Create backup/restore action.....	177
22.2 PLC-controlled sending of messages.....	178
22.2.1 Connection of the device.....	178
22.2.2 Access to the device.....	178
22.2.3 Configure SMS service.....	178
22.2.4 Configure mailing.....	179
22.2.5 Create PLC connection.....	179
22.2.6 Create PLC value.....	180
22.2.7 Create message.....	181
22.2.8 Using messages from PLC.....	182
22.3 Processing process values in the control	183
22.3.1 Connection of the device.....	183
22.3.2 Access to the device.....	183
22.3.3 Create PLC connection.....	183
22.3.4 Create PLC value.....	184
22.3.5 Link PLC value to process value.....	185

1 General

1.1 About the manual

This manual describes the devices from the “EtherSens family” and can be downloaded on the web page of the product via main downloads → documentation.

The devices are aimed to the following user groups:

- planners
- operators
- commissioning staff
- service and maintenance staff

Before you use the device, you should read this manual.

If you have questions and / or problems you can contact the technical support of your distribution partner.

2 System requirements

2.1 Software

For using and configuring the EtherSens devices you need the following tools and software's:

- internet browser (e. g. Microsoft Internet Explorer, Mozilla Firefox or Google Chrome)
- SMTP server (only needed for sending e-mails)
- FTP server (only needed if the recording to a server is wished, e. g. FileZilla Server)

Using the EtherSens device is independent of your operating system and browser.

Important:

For viewing the website correctly you should check that JavaScript isn't disabled in your browser.

2.2 Hardware

- WLAN interface
- Ethernet interface (LAN)
- 230VAC power supply (L1 / N for power supply) for EtherSens **MONI**, EtherSens Energy and EtherSens Control-Relais (with 230VAC supply)
- 24VDC power supply for EtherSens **MONI**, EtherSens Control and EtherSens Basic
- USB power supply from the PC, power-pack for EtherSens **MONI**

3 Commissioning

All EtherSens devices have a built in LAN and WLAN interface. The interfaces can be used at the same time. To open the web server of the device you have to open your browser and type in the IP address of the LAN or WLAN interface.

3.1 WLAN communication

The WLAN interface of the EtherSens devices creates an own network and working as Access Point from factory state. To connect your PC / Laptop to the network, open the network search and look at the network list.

Under the shown networks there should be a WLAN network named "EtherSens WiFi". Now you can connect to it. To access the website of the device you maybe have to change the network settings from your PC. If you have DHCP enabled, EtherSens gives your PC an IP address from the range 192.168.1.100 to 192.168.1.199. Alternatively you can give your PC a manual IP address which comes from the subnet 192.168.1.xxx. The IP address 192.168.1.58 can't be used because it's the default IP address of the WLAN interface of the EtherSens.

On the web server you can change the settings for the WLAN interface. Thus you can connect the EtherSens with another Access-Point in your network. Furthermore it's possible to disable the complete WLAN interface.

The WLAN module supports the channels 1 to 11 and can thus be used in Europe, America and other countries.

Important:

If EtherSens can't connect with your Access-Point please check if your Access-Point opens a network within the channel range named above. If the Access-Point opens a network in channel 12 or 13 please change the channel from your Access-Point.

3.2 LAN communication

Connect the RJ45 plug from your PC with the RJ45 plug from your EtherSens device. Either you choose a patch cable or a cross link cable (with crossed pins). This is possible because the EtherSens device supports the Auto MDIX technology and can detect the transmit and receive direction by itself.

After the physical connection is done the EtherSens device can distribute an IP address to your PC. If you don't want to activate DHCP on your PC, you can give your PC an IP address from the subnet 192.168.1.xxx (range from 192.168.1.1 to 192.168.1.254). Do not give your PC the IP address 192.168.1.59, because this IP address is used by the LAN interface of the EtherSens.

3.3 User interaction

The devices have a bi-color LED on the front side of the case, which gives you short information about the status.

green:	ON	device ready
	OFF	device executes a restart or is powered off
red:	ON	device is booting
	flashing at device boot	device is updating the <i>firmware</i>
	flashing 0,5 Hz	<i>device is logging data</i>
	fast flashing	<i>output of error codes (see below)</i>

List of error codes:

- 1x flash: Initialization error of a sensor.
- 2x flashes: Space on the SD card smaller than 1 Kilobyte or SD card removed without logging off.
- 3x flashes: Error at last mail transfer (SMTP).
- 4x flashes: Error at last time adjusting (NTP).
- 5x flashes: No network connection available (only when there isn't a connection to the Access-Point and no LAN link state available).

When you want to reset your device (factory settings) you can press the reset button for 3s to 10s while the device is booting. The button must be pressed with the help of a paperclip and can be found on the bottom / back of the device.

3.4 Web server

Open your internet browser and type in one of the following IP addresses into the address line:

for WLAN: 192.168.1.58

for LAN: 192.168.1.59

Afterwards the web server from you EtherSens device should show the following start page on the browser:

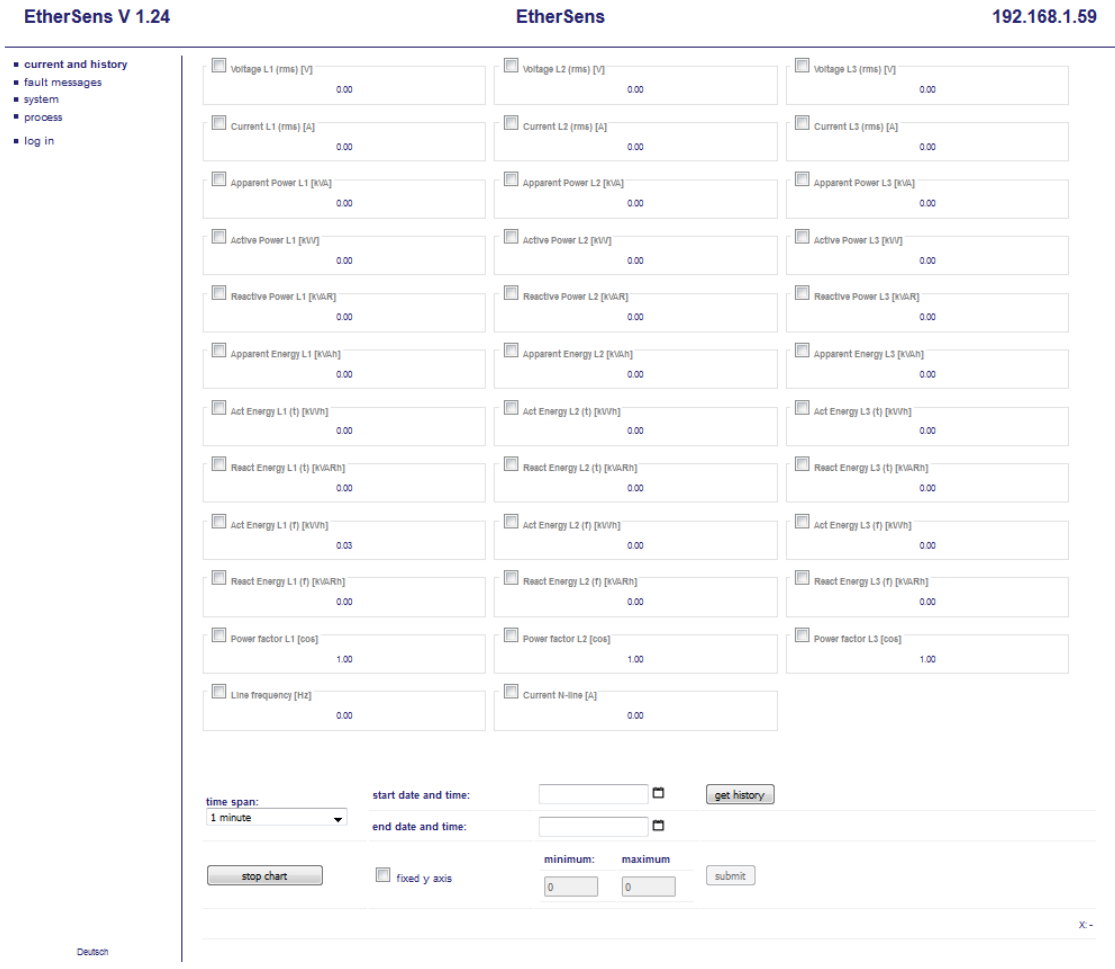

The view of the start page can vary by different device types or versions. The picture above shows the start page of a EtherSens Energy device.

4 Web server

4.1 Menu item current and history

The menu item “current and history” is also the start page of the web server. The page can be used to view the current values of all process values.

<input type="checkbox"/> Spannung L1 (rms) [V]	234.66	<input type="checkbox"/> Spannung L2 (rms) [V]	235.38	<input type="checkbox"/> Spannung L3 (rms) [V]	234.52
<input checked="" type="checkbox"/> Strom L1 (rms) [A]	1.92	<input checked="" type="checkbox"/> Strom L2 (rms) [A]	13.74	<input checked="" type="checkbox"/> Strom L3 (rms) [A]	16.73
<input type="checkbox"/> Scheinleistung L1 [kVA]	0.45	<input type="checkbox"/> Scheinleistung L2 [kVA]	3.22	<input type="checkbox"/> Scheinleistung L3 [kVA]	3.90
<input type="checkbox"/> Wirkleistung L1 [kW]	0.36	<input type="checkbox"/> Wirkleistung L2 [kW]	2.67	<input type="checkbox"/> Wirkleistung L3 [kW]	3.79
<input type="checkbox"/> Blindleistung L1 [kVAR]	0.13	<input type="checkbox"/> Blindleistung L2 [kVAR]	0.86	<input type="checkbox"/> Blindleistung L3 [kVAR]	-0.03
<input type="checkbox"/> Scheinenergie L1 [kVAh]	2129.20	<input type="checkbox"/> Scheinenergie L2 [kVAh]	5723.50	<input type="checkbox"/> Scheinenergie L3 [kVAh]	6837.20
<input type="checkbox"/> Wirkenergie L1 [kWh]	1865.10	<input type="checkbox"/> Wirkenergie L2 [kWh]	4782.50	<input type="checkbox"/> Wirkenergie L3 [kWh]	6310.30
<input type="checkbox"/> Blindenergie L1 [kVARh]	635.80	<input type="checkbox"/> Blindenergie L2 [kVARh]	1815.10	<input type="checkbox"/> Blindenergie L3 [kVARh]	-1613.70
<input type="checkbox"/> Leistungsfaktor L1 [cos]	0.94	<input type="checkbox"/> Leistungsfaktor L2 [cos]	0.89	<input type="checkbox"/> Leistungsfaktor L3 [cos]	1.00
<input type="checkbox"/> Netzfrequenz [Hz]	50.03				

If you have one or more process values which are defined as an output or an internal value, you will see a text field and button in addition to the current value. The value in front of the text field is the current value. The value within the text field is only loaded at the page loading and doesn't get refreshed during runtime. Writing values are only available for logged in users. To submit the entered value you have to click on the button “write” or if your focus is on the text field just press the enter key.

Output 1

0.00 0.00

When you click on the checkbox of a process value, the process value will be shown in the chart below.

It is possible to select and view multiple process values. The number of shown values as well as the time interval between the values can be configured within the menu item “system” → “general”.

Values where a color is defined in the configuration are shown in the chart by default. This values can be hided by deselected the checkbox.

If you have multiple process values with the same color you can change the color of the value in the legend above the chart temporarily. In this way the setting gets not changed but the color in the chart does. This temporary setting gets lost when you navigate to another site. If you want to change the color permanent, you have to change the color settings on the process value pages.



If you select the checkbox “fixed y-axis” it is possible to show a fixed y-axis instead of a dynamic y-axis. After you have selected the checkbox the text fields “minimum” and “maximum” and the button are enabled. Next you can enter values in the two text fields and click to “submit”. Now you can see that the y-axis in the chart is fixed. If you want to see the dynamic axis again, just deselect the checkbox. The setting gets submitted directly. The setting for the y-axis gets stored until a reboot of the device.



Important:

If you have a dynamic y-axis the values in the chart are grouped by the unit of the process value. This ensures that values like voltage (V) and current (A) aren't shown within the same scale.

If you have multiple process values with the same unit but a different format (e. g. decimal and hexadecimal), the Y axis will show the values in each used format.

The current chart can be stopped with the button “stop chart”. This is helpful if you want to have a closer look to the values in the chart. With the same button which now should show the text “continue chart” the refreshing of the chart can be resumed.

When you click at the button “get history” the history values of your selected process values are getting loaded from the recording on the SD card. Therefore you have to fill in the text fields “start date and time” and “end date and time” first. If you just want to see e. g. the last 15 minutes or the last 1 hour you can use the drop down list “time span”. After selecting an element the value of the text fields are adjusted automatically.

time span: start date and time:
 end date and time:

The following image shows an example of a loaded history:

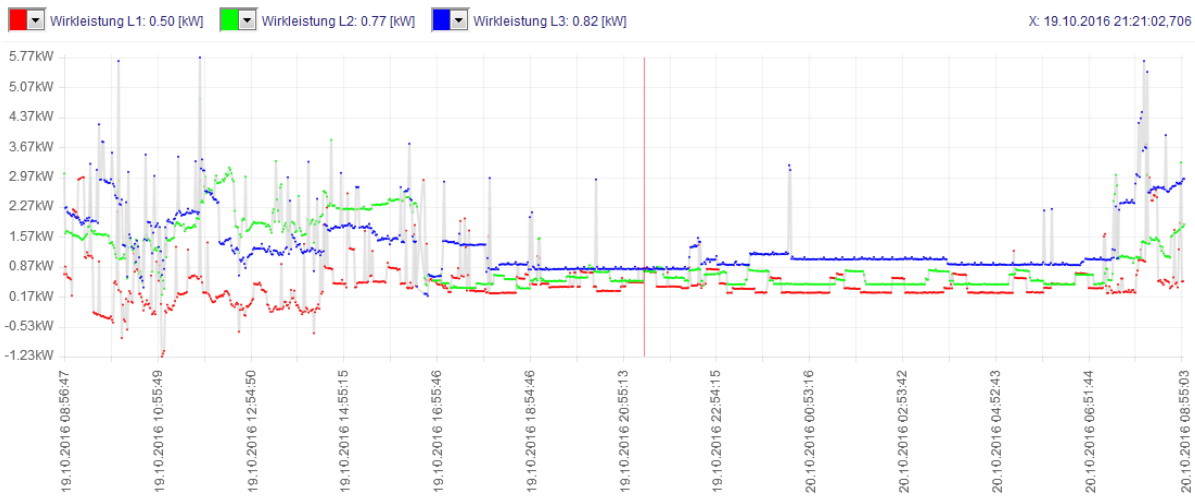

Within the chart and with the help of your cursor you can move a red line on the chart. Above the chart you can see the current values and the date and time which belongs to the red line. This ledger line is also available in the current chart.

Another feature of the ledger line in the history chart is the “zooming” function. To use this feature just position your cursor at the wished starting point and hold down the left mouse button. Now move your cursor to the wished ending point while holding down the mouse button. You should see that the range is colored gray. After you release your mouse button the “new” history gets loaded automatically. A zoomed history causes a more detailed resolution. The values in the text fields above get not changed at “zooming”.

Important:

If you have selected a value it will be shown in the legend above the chart. But if you don't see the value within the chart, this means that the value wasn't recorded at the specified time.

After a history was loaded successfully, the button "export" gets shown below the button "load history". If you click on this button a pop up will open, where you are able to specify the target location of the export:

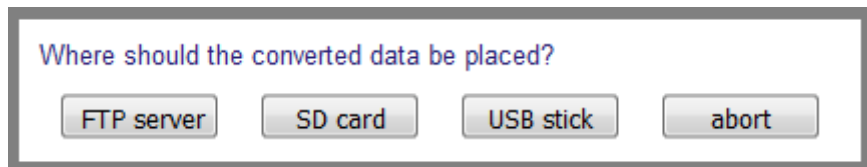

If you have chosen a target, the export will start automatically. Instead of the export button you will see a progress bar now. This progress bar indicates the state of the export. If you are using the separated history the name of the process value is also shown. Furthermore a abort button will be shown, which allows you to abort the export of the history data.

When you have process values on your device with power data (units W, VA or VAR) you can enable the option "evaluate data" within the line "energy evaluation" below the input fields for the time span. Thereby the data of this process values gets summed up specially while loading the history and can then afterwards be viewed in a separate pop up after clicking on the button "show data". Through this you have an overview about how many energy was consumed and fed back within the specified time span.

energy evaluation			
	positive energy	negative energy	total energy
Active Power L1	8.47 kWh	-21.29 kWh	-12.82 kWh
Active Power L2	30.83 kWh	-12.08 kWh	18.75 kWh
Active Power L3	32.58 kWh	-7.66 kWh	24.92 kWh
	71.88 kWh	-41.03 kWh	30.85 kWh

close

Hint:

When you enable the option “evaluate data” the loading process of the history may take a bit longer.

If you want to see the current chart again just click at the button “current chart”.

4.2 Menu item fault messages

The menu item “fault messages” allows you to view a history of the last fault messages. A fault messages arises through a limit value which is sent via e-mail (default message or own message). A limit values who writes a value to another process value isn't a fault message. The history of the fault messages is saved on the SD card in the file messages.bin. If messages are saved on the SD card and how many messages should be saved depends on the configuration (see menu item system → storage → settings).



<input type="checkbox"/>	date and time	process value	subject	acknowledgement	
<input type="checkbox"/>	17.05.2017 16:06:57	test 1	value is bigger than 30	pending	✓
<input type="checkbox"/>	17.05.2017 16:06:50	test 1	value is smaller than 1	pending	✓
	17.05.2017 16:06:39	test 1	value is 20	not needed	—
	17.05.2017 16:06:33	test 1	value is bigger than 30	17.05.2017 16:07:04	—
	17.05.2017 16:06:26	test 1	value is 10	not needed	—

delete all messages acknowledge checked messages

The view is organized as table and is ordered to the date and time of the message. Every line shows one message. The newest message is always on the first line. If you click on the ↻ icon the message list will be reloaded.

As you can see the table is not big enough to show all information about a message. So it is possible to click on a message to open a pop up. In the pop up window all information about a single message is shown:



fault message	
process value:	test 1
value:	35
limit value:	30
date and time:	17.05.2017 - 16:06:33
receiver:	test@example.com
subject:	value is bigger than 30
message:	The value has exceeded the limit value 30.
acknowledgement:	17.05.2017 - 16:07:04

close

If you want to acknowledge a message you have to click on the ✓ icon which is shown on the end of a table row. When needed you can mark multiple messages (with the check box on the front of a table row) and click on the button “acknowledge checked messages”.

For deleting a message you have to click on the — symbol. A click on this symbol will delete the selected message and all previous (older) messages. Please notice that only acknowledged messages (or messages who don't need to be acknowledged) can be deleted. If you want to delete all messages (this is only possible if there is no message who needs to be acknowledged) you can click on the button “delete all messages”.

Important:

Acknowledging and deleting messages is only allowed if you are logged in on the web page.

If you are on the web page and a limit value has reached it's limit, the fault message will be shown on a orange colored field in the content area of the web page once. Fault messages who need to be acknowledged are also shown in this area, but they are shown until the message is acknowledged. If all messages are viewed once the first will be shown again and so on.

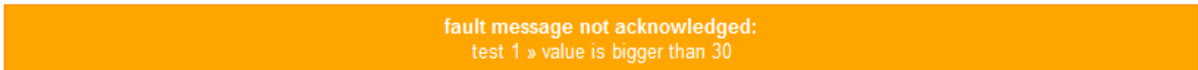

4.3 Menu item system

general			
actual time:	17.05.2017 - 16:20:04 (summer time)		
product name:	EtherSens		
device name (netBIOS name):	EtherSens		
bootloader version:	1.07		
firmware version:	1.24		
serial number:	10203040		
support request:	<input type="button" value="send e-mail with configuration"/>		

network and WIFI			
	WLAN	LAN	LTE
state:	connected	connected	not connected
DHCP client:	disabled	disabled	-
DHCP server:	enabled	enabled	-
IP address:	192.168.1.58	192.168.1.59	0.0.0.0
MAC address:	00:1E:00:1B:3E:FF	08:30:39:70:06:69	-
subnet mask:	255.255.255.0	255.255.255.0	0.0.0.0
gateway:	192.168.1.1	192.168.1.1	0.0.0.0
primary dns server:	192.168.1.1	192.168.1.1	0.0.0.0
secondary dns server:	0.0.0.0	0.0.0.0	0.0.0.0
uptime:	01:10:10	01:10:08	-
current channel:	1	-	-

LTE module	
SW revision:	-
IMEI number:	-
SIM state:	-
PIN/PUK attempts:	-
signal strength:	-
network login state:	-
network login state GPRS:	-
network operator:	-
network type:	-
DDNS state:	-
Last DDNS update:	-

FTP server	
client state:	ready
recording:	recording not running
working directory:	\

SMTP server	
send time:	-
send cause:	-
response:	-

SD card	
status:	SD card is ready
disk space:	29.62 GB of 29.71 GB free
recording:	recording not running
remove safely:	<input type="button" value="remove SD card safely"/>

In this menu item you can see the most important system configurations and the current status of the device (*image equals to version 1.24*).

If you are logged in on the web page you can send an e-mail to the support of Process-Informatik by clicking on the button “send e-mail with configuration”. If there is not SMTP server specified on your device a download prompt with the configuration file of the device will be shown. You have to save this file on your PC. After a few seconds an e-mail window will appear. In this window you can type in your message and have to attach the downloaded file. The fields for the receiver and the subject are filled out automatically.

In the case that you have specified an e-mail-server a pop up window in you browser will be shown after clicking on the button. In this pop up you can also type in the message which should be send to the support. The delivery of the mail goes throw the entered SMTP server and not throw the e-mail account of your local PC. All necessary fields like sender, receiver, subject and the configuration file are configured automatically.

support e-mail

sender address:	test@example.com
receiver address:	hotline@process-informatik.de
subject:	question about EtherSens device #10203040
message:	<div style="border: 1px solid gray; height: 100px;"></div>
attachment:	device-config.bin

alternative: send e-mail via locale PC

Furthermore if a SD card is plugged in, the button “remove SD card safely” is enabled. When you click on it the SD card get logged out and thus ensures that the SD card isn’t used anymore. After clicking on the button you can remove the card from you device.

The same applies to the USB stick, which can be (if connected) logged out via “remove USB stick safely”.

Important:

Please note, that the USB stick gets detected if the USB mode is enabled only.

The menu item “system” has also the following sub menu items:

- general
- network and WiFi
- USB
- serial interface
- date and time
- e-mail
- storage

On all of these pages the device can be configured. Changing the configuration is only possible when you are logged in on the web server. Without logging in the configuration can only be viewed. Sensitive information like passwords aren't viewed if you are not logged in. The settings on this pages affects the configuration which is named “user configuration” in the following topics. All configurations, except the network and WiFi configuration, on this pages can be changed by any user type.

4.3.1 Menu item general

general	
device name (netBIOS name):	<input type="text" value="EtherSens"/>
language:	<input type="radio"/> German <input checked="" type="radio"/> English
language of process list:	<input type="checkbox"/> translate process list to selected language
display of the menu tree:	<input checked="" type="checkbox"/> show menu tree permanently
refresh rate current values:	<input type="text" value="1s"/>
datasets per line (main page):	<input type="text" value="3"/>
value count current chart:	<input type="text" value="24"/>
scale position (chart):	<input type="text" value="left"/>
line view (chart):	<input type="text" value="bézier curve"/>
dot view (chart):	<input checked="" type="checkbox"/> show dots
default instrument:	<input type="text" value="nothing"/> → automatic redirect: disabled
automatic configuration backups:	<input checked="" type="checkbox"/> enable
automatic calibration backups:	<input checked="" type="checkbox"/> enable
user configuration:	<input type="button" value="backup (browser)"/> <input type="button" value="restore (browser)"/> <input type="button" value="backup (SD card)"/> <input type="button" value="restore (SD card)"/>
process list:	<input type="button" value="backup (browser)"/> <input type="button" value="restore (browser)"/> <input type="button" value="backup (SD card)"/> <input type="button" value="restore (SD card)"/>
calibration data:	<input type="button" value="backup (browser)"/> <input type="button" value="restore (browser)"/> <input type="button" value="backup (SD card)"/> <input type="button" value="restore (SD card)"/>
MIB file (SNMP):	<input type="button" value="export (browser)"/> <input type="button" value="export (SD card)"/>

- device name:** The name of the device (for viewing in the headline as well as for network access with a name instead of a IP).
- language:** Switching between German and English (alternative with the help of the language view on the bottom of the menu).
- display of the menu:** Determines if the menu on the left side should be showed permanently. Otherwise the menu is hidden by default and can be faded in temporarily by clicking on the symbol ≡ on the upper left corner of the head line.
- refresh cur. values:** Selection of the refresh rate for the current values on the main page and instrument pages.
- datasets per line:** Count of the “blocks” for the current values on the start page in one line.
- value count cur. chart:** Maximum count of values shown in the current chart on the start page. The visible time span is calculated by value count * refresh rate.

scale position:	Position of the y-scales in the chart.
line view:	Selection of the view type for the lines which is drawn between two data points in the chart.
dot view:	Determines if a point for the data points in the chart should be shown. Otherwise only lines are shown between two data points.
default instrument:	Selection of an instrument which should be automatically viewed after a specified time.

If you have selected the checkbox “translate process list to selected language” and click on the “save” button, the complete process list get translated to the current language. This concerns the default names of devices and process values. Names that do not correspond to the origin or added manually are not translated. After the save procedure the checkbox gets deselected automatically.

The option “automatic configuration backups” determines if the settings should be automatically saved on the SD card in the files “config.akt” and “processlist.akt”.

Attention:

These .akt files are overwritten every time you click on the “save” button on one of the pages of the web server.

The option “automatic calibration backups” determines if the calibration configuration should be backed up on the SD card. The current calibration configuration is always located in the file “calibration.akt”, if this setting is enabled. If the calibration settings are changed the file gets renamed to “calibration_xxxxx.bak” (the newest file has the highest number) and a new “calibration.akt” gets created. Thereby you get an history of your calibrations, which can be restored at any time.

The user configuration (web page part “system”), the process list (web page part “process”) and the calibration of your device can also be backed up manually on the SD card by clicking on one of the “backup (SD card)” buttons.

The file name of the user configuration and the process list is attached by the current date and time. Thereby the backed up files are unique and protected from overwriting.

The manual backup of the calibration can be useful if the function for the automatically backup is disabled. The file which gets created in this step has the name “calibration.akt”. The old “calibration.akt” file gets renamed to an backup with an unique number as described above.

If you want to save the configuration to your PC you can click on the button “backup (browser)”. After you clicked on the button you should see a download prompt from your browser.

After you have clicked on one of the buttons to create a backup on the SD card, a loading symbol should be displayed and the fields should be grayed out. When the loading symbol disappears, the backup process is completed.

If you backup a process list to your SD card first you will see a confirm box where you have to select, if you want to add a country code. If you want to add a country code a pop up window will be shown in which you can enter that code:

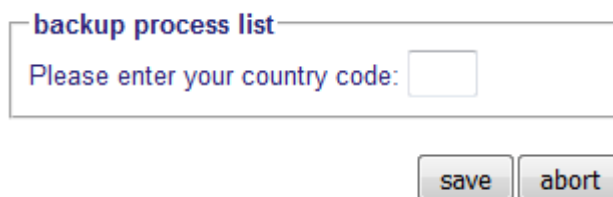

backup process list

Please enter your country code:

save abort

If you want to restore a saved backup you can click on one of the “restore (SD card)” buttons . Now a pop up should be opened in which you can see all available backup files. After clicking on the  icon the device executes a restart and the configuration gets restored. The file will remain unchanged on the SD card. The following image shows the pop up window for restoring the user configuration.

restore user configuration

SD card ↻

file name	change date	file size	
config.akt	22.07.2016 09:08:10	2 KB	🔑
config_2016-07-14-16-14-10.bak	22.07.2016 12:02:28	2 KB	🔑
config_2016-07-22-12-02-15.bak	22.07.2016 12:02:14	2 KB	🔑

The next image shows the pop up for restoring a process list. There you can see a selection list for the different country codes. After selecting a country code only the files with the selected country code are shown:

restore proces list

SD card ↻ → language:

file name	change date	file size	
processlist.akt	24.10.2016 09:46:30	14 KB	🔑
processlist_2016-10-12-08-03-28.bak	12.10.2016 08:03:28	34 KB	🔑
processlist_2016-10-20-09-30-24_de.bak	20.10.2016 09:30:22	15 KB	🔑

Alternatively you can also restore a configuration directly from a file on your PC. To do this, first click on the button “restore (browser)”. Then a pop up will be opened where you can click on the button “Browse...” to select the file on your PC. Finally you have to click on “restore config” and confirm the prompt. After the file has uploaded the device will restart and submit the configuration. The following images shows the dialog for restoring a user configuration:

restore user configuration



When you click on the button “export (SD card)” in the line “MIB file (SNMP)” you can generate a MIB file and save it to the SD card. This file always has the file name “EtherSens.mib”. The MIB file can be imported at some SNMP management software. Through this you don't have to

type in all OIDs manually. The structure of the OIDs are described in the chapter “process server”. If you want to export the file to your PC you can click on the button “export (browser)”.

4.3.2 Menu item network and WiFi

network		
	WLAN	LAN
DHCP setting:	DHCP server ▾	DHCP server ▾
IP address:	192.168.1.58	192.168.1.59
subnet mask:	255.255.255.0	255.255.255.0
gateway:	192.168.1.1	192.168.1.1
primary dns server:	192.168.1.1	192.168.1.1
secondary dns server:	0.0.0.0	0.0.0.0
network bridging:	<input type="checkbox"/> enable	

The following settings are available for the LAN and WLAN interface:

- DHCP setting: disabled (without function)
 DHCP client (device obtains a IP address from a DHCP server)
 DHCP server (device distribute IP addresses to other devices)
- IP address: IP address of the device.
- subnet mask: Subnet mask of the device.
- gateway: IP address from the gateway.
- prim. DNS server: IP address from the primary DNS server.
- sec. DNS server: IP address from the secondary DNS server.
- network bridging: There you can enable the bridging function between the LAN and WLAN interface.
(Attention: Throughput maximum 3 Mbit/s!)

WiFi

activation: enable WiFi network

network type: Access Point (AP) Infrastructure network

SSID:

security type:

password:

channel:

scan:

For the configuration of the WiFi interface there are some more settings available:

activation: If the checkbox is not selected the interface is completely disabled.

network type: With this function you can select between infrastructure network (*device is connecting to a Access-Point*) and Access-Point mode (*EtherSens creates a Access-Point by itself*).

SSID: Name of the WLAN network.

security type:	Open	no security
	WEP	WEP 64 bit / 128 bit
	WPA	WPA
	WPA2	WPA2
	WPA / WPA2	WPA or WPA2 (<i>device chooses the type</i>)

password: Entering the password (hexadecimal or ASCII).

channel: Here you can choose the channel (1 – 11) from your WLAN network on which you want to connect.

The setting “auto channel” causes the device to detect the channel by itself.

scan: Search for available and visible WiFi networks.

To execute a scan you have to click on the button “search for WiFi networks”. Now a short text with a loading symbol should be displayed. After about 5s to 10s a list of all available networks will be shown:

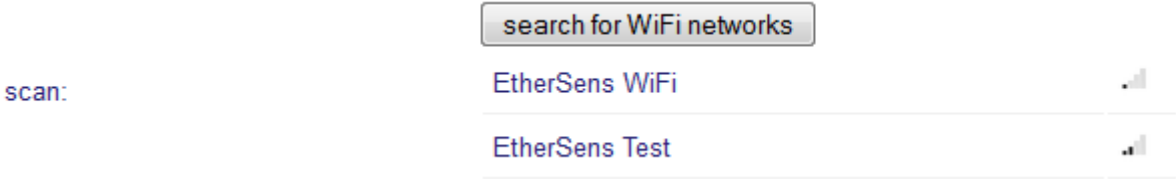

After the scan was executed you can click on one of the shown entries. Thereby the fields above are filled in as far as possible.

Important:

The scan for WiFi networks can only be executed if your device is in infrastructure mode.

In the operating mode Access-Point only the security types “Open” and “WEP” are available. Other security types can’t be chosen.

For configuring the DDNS service (Dynamic DNS) for the LTE module the following settings are available:

- provider:** Here you can choose the provider of the DDNS service. If you don't need the DDNS service or don't have a LTE module you can choose the setting “none”.
- domain name:** The domain name for which the IP address should be updated.
- username:** The username which is needed to log in to the DDNS account.
- password:** The password which is needed to log in to the DDNS account.

Important:

Using the DDNS service is only useful if your SIM card has a public IP address. If your provider doesn't provides you a public IP address your device can't be accessed via the internet.

Important:

The configuration on this page can only be changed by the expert or master user.

After pressing the “save” button the settings will be submitted and the device will restart. After the device boot your device is available under the new settings only.

4.3.3 Menu item USB

USB

mode:

- disabled
- use LTE module and USB storage stick on EtherSens
- SD card as mass storage at PC

For the basic configuration of the USB interface the following settings are available:

mode:

- disabled: the USB interface is not used
- LTE module and USB storage stick: the USB interface of the EtherSens works as a host (you can connect a device to the EtherSens)
- SD card as mass storage: the USB interface works as a device (you can connect the EtherSens to a PC) and provides the SD card as a removable device on your PC

Important:

The LTE module is (if present) connected with the USB port of the EtherSens internally.

If you use the SD card as mass storage on your PC via the MONI, the SD card isn't available anymore for the MONI device. So in this case e. g. a recording or firmware-updates will be interrupted.

LTE module

SIM pin:	<input type="text" value="...."/>	
access point name (APN):	<input type="text"/>	
username:	<input type="text"/>	
password:	<input type="text"/>	
SMS limit monitor:	<input type="checkbox"/>	use SMS limit monitor
SMS PLC messages:	<input type="checkbox"/>	use SMS PLC messages
SMS receiver:	<input type="text"/>	

To configure the LTE module some more settings are available:

SIM pin: The pin of the SIM card (the pin 0000 is not used).

access point name (APN): The APN of your provider (e. g. INTERNET for O2).
No connection to the Internet is established without entering the APN!

username: The username which is needed to log on to the APN (maybe not necessary).

password: The password which is needed to log on to the APN (maybe not necessary).

SMS limit monitor: Send a SMS when a limit value was reached (see *“process”* → *“limit values”*).

SMS PLC messages: Activation of PLC message sending (see *“process”* → *“PLC messages”*).

SMS receiver: Telephone number of the SMS receiver.

Important:

If you do not like your SIM card to connect to the internet automatically, just leave the input field “access point name (APN)” empty.

4.3.4 Menu item serial interface

serial interface

mode: L1 bus master Modbus master Modbus slave

baud rate: 9600 baud

parity: even odd none

stop bits: 1

To configure the serial interface in general the following settings are available:

- mode: The usage of the serial interface.
- baud rate: The baud rate for the serial interface.
- parity: The parity for the serial interface.
- stop bits: The amount of stop bits used for the serial interface.

Important:

If you use the mode “Modbus master” or “Modbus slave” in combination with the setting ASCII mode the setting no parity with 1 stop bit isn't possible.

If you use a setting combination which is not standardized for the selected mode a warning will be displayed.

Modbus

transmission mode: RTU ASCII

slave address: 1

If you use the serial interface for Modbus communication some more settings are available:

- transmission mode: The mode for the communication (RTU, ASCII).
- slave address: The address of the EtherSens device, if the device works as slave.

4.3.5 Menu item date and time

date and time

NTP client: use NTP client

NTP network interface: WiFi LAN LTE

NTP server address:

manual date and time: 18.05.2017 08:49:44

time zone: UTC + 01:00 ▾

time change: enable automatic daylight saving time change

save

The EtherSens device comes with an actual date and time. This information is hold in a battery backed RTC (*Real-Time-Clock*).

By activating the function “use NTP client” the device requests the date and time by the entered NTP server. The manual entering and the information from the RTC get overwritten by the response from the NTP server.

Because the device has with the help of integrated RTC a reliable time source, the device offers the possibility to provide the current date and time to other devices in the network. Therefore the EtherSens and **MONI** device contains an SNTP server.

The following settings are available:

NTP client:	Enables or disables the using of the NTP server.
NTP network interface:	Here you can choose the network interface which should be used to access the NTP server.
NTP server:	IP address or DNS name (e. g. ptbtime1.ptb.de) from the NTP server.
manual date and time:	Manual entering of date and time. This setting will only be submitted if the checkbox in front of the text field is checked.
time zone:	Here you can choose your time zone. The time zone will be included in all date and time outputs.
time change:	Automatically daylight saving time change.

4.3.6 Menu item e-mail

e mail	
system monitor:	<input type="checkbox"/> use system monitor → repeated sending: disabled
limit monitor:	<input type="checkbox"/> use limit monitor
PLC message sending:	<input type="checkbox"/> use PLC message sending
PLC messages subject:	<input type="text"/>
e-mail reception:	<input type="checkbox"/> use e-mail reception
e-mail polling interval:	<input type="text" value="5"/>
PLC message reception:	<input type="checkbox"/> use PLC message reception

To configure the e-mail sending and receiving in general the following settings are available:

system monitor:	Send an e-mail when a system message occur (see below).
repeated sending:	Time span for system mails in which they should send. If you have selected the function “disabled” the e-mails are only getting sent once.
limit monitor:	Send an e-mail when a limit value was reached (see “process” → “limit values”).
PLC message sending:	Activation of PLC message sending (see “process” → “PLC messages”).
PLC messages subject:	Subject, which should be used in e-mails sent as PLC messages. If this field is empty the subject “PLC message EtherSens” will be used.
e-mail reception:	Activation of e-mail reception.
e-mail polling interval:	Interval in minutes, in which the mailbox gets checked for e-mails.
PLC message reception:	Activation of PLC message reception (see “process” → “PLC messages”).

Reason list for system e-mails:

- device start
- SD card unplugged without logging it out (on the web server).
- free storage size on the SD card smaller than 10%.
- free storage size on the SD card smaller than 1 Kilobyte.
- recording stopped because 65535 backup files exist.

- recording stopped because on the SD card isn't space for another backup file.

Important:

The system mail for the device start gets always sent once, also when you have enabled the function for repeated sending.

SMTP server

network interface: WiFi LAN LTE

server address:

server port:

encryption: use SSL/TLS encryption

character set:

username:

password:

sender mail address:

receiver mail address:

test e-mail:

For configuring the SMTP server the following settings are available:

network interface:	Here you can choose the network interface which should be used to access the SMTP server.
server address:	IP address or DNS name (e. g. mail.gmx.net) from the SMTP mail server.
server port:	Port address from the SMTP mail server. (default: 25; 465 for SSL/TLS)
encryption:	SSL/TLS encryption for the connection.
character set:	Character set / encoding of the e-mail.
username:	Username from the used e-mail account.
password:	Password from the used e-mail account.
sender mail address:	E-mail address of the sender or from the used e-mail account.
receiver mail address:	E-mail address of the receiver.
test e-mail:	Test of the e-mail transfer with the specified configuration.

Important:

If you select “ASCII” as character set, some special characters (e. g. ä, ö, ü) are replaced by a white space. Please only use this setting if it's really necessary.

When clicking to the button “send e-mail” a pop up window will be displayed. In the window messages from the test transfer are shown. This messages can help you to find the error if the connection should fail.

Important:

It is necessary to save the settings via the “save” button before you execute the e-mail test.

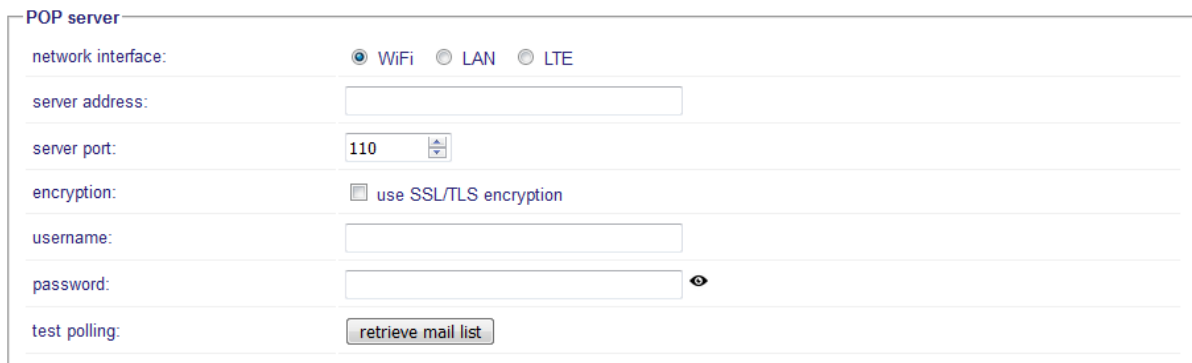

The screenshot shows a configuration window titled "POP server". It contains several fields and a button:

- network interface:** Three radio buttons for "WiFi" (selected), "LAN", and "LTE".
- server address:** A text input field.
- server port:** A dropdown menu showing "110".
- encryption:** A checkbox labeled "use SSL/TLS encryption".
- username:** A text input field.
- password:** A text input field with an eye icon for toggling visibility.
- test polling:** A button labeled "retrieve mail list".

The configuration of the POP server can be done with the following settings:

- | | |
|--------------------|--|
| network interface: | Here you can choose the network interface which should be used to access the POP server. |
| server address: | IP address or DNS name (e. g. pop.gmx.net) from the POP mail server. |
| server port: | Port address from the POP mail server.
<i>(default: 110; 995 for SSL/TLS)</i> |
| encryption: | SSL/TLS encryption for the connection. |
| username: | Username from the used e-mail account. |
| password: | Password from the used e-mail account. |
| test polling: | Test of the e-mail reception with the specified configuration. |

When clicking to the button “retrieve mail list” a pop up window will be displayed. In the window messages from the test transfer are shown. This messages can help you to find the error if the connection should fail.

Important:

It is necessary to save the settings via the “save” button before you execute the test reception.

4.3.7 Menu item storage

The menu item “storage” has some sub menu items: the page “settings” and a “file manager” page for each storage media (SD card, USB stick and FTP server). When you click directly to the “storage” menu item you will be redirected to the “settings” sub menu item. The sub menu items “file manager” are only visible if you are logged in and if the storage media is connected (for the SD card and the USB stick) or configured (for the FTP server).

4.3.7.1 Menu item settings

storage kind:	<input checked="" type="radio"/> combined <input type="radio"/> separated
storage clock combined history:	1m
value change combined history:	<input type="checkbox"/> execute recording on value change
SD recording:	<input type="checkbox"/> enable recording
history buffer length:	1 month ▼
history backups:	<input type="checkbox"/> create backups on the SD card
name file combined history:	<input type="checkbox"/> create file with process value names on the SD card
CSV recording:	disabled ▼
date format:	format: YYYY-MM-DD ▼

The following settings belong to the storage of process values:

- | | | |
|----------------|--|---|
| storage kind: | combined: | one file for all values
(<i>history.bin</i>) |
| | separated: | each value has an own file
(<i>e. g. Voltage L1.bin</i>) |
| storage clock: | The clock rate in which the process values should be recorded, if the storage kind is “combined”. If you click on the time value a pop up window will be opened, where the value can be changed. | |
| value change: | Determines if a data set should be recorded, when the value of a process value which gets recorded and checked for changes gets changed, if the storage kind is “combined”. If the storage clock is specified too, then a recording is also done, when no value from a process value got changed for the specified time. | |

- SD recording: Save values on the SD card in binary format (needed for the history or for power fail values).
- history buffer length: Specifies how long the process values should be stored on the SD card (only relevant to “SD recording”). If the file end is reached the file gets overwritten except you have enabled the function “history backups”. If this function is enabled after the file end is reached the file gets renamed and a new file will be created.
- history backups: Specifies if the history files should be stored as a backup when the file end was reached (only relevant to “SD recording”). If the function is disabled the history files get overwritten.
- name file: Specifies if an additional file with the names of the recorded process values should be created for the history file, if the storage kind is “combined”. This *.nam file can be used for a header from the CSV converter.
- CSV recording: Specifies if the values should be stored on a FTP server, on the SD card or on a USB stick in CSV format.
- date format: The format of the date and time in CSV files. When using the format “unix time” you have to note that the time is stored in milliseconds rather than the normally used seconds.

Important:

The function “SD card” in the selection “CSV recording” reduces the life time of the SD card.

The screenshot shows a settings window titled "fault messages". It contains two main settings: "storage:" with a checked checkbox labeled "save messages on the SD card", and "number of messages:" with a text input field containing the value "100" and small up/down arrow icons.

The following settings belong to the storage of fault messages:

- storage: Specifies if fault messages should be saved on the SD card.
- number of messages: The number of fault messages which should be stored on the SD card.

FTP server

connection mode: activate pasive mode
 keep connection

network interface: WiFi LAN LTE

server address:

server port:

username:

password: 

path:

connection test:

The following settings are needed when using a FTP server:

- connection mode: activate passive mode (*often needed for accesses through a firewall*)
keep connection (*recommended for fast recordings to the FTP server*)
- network interface: Here you can choose the network interface which should be used to access the FTP server.
- server address: IP address or DNS name from the FTP server.
- server port: Port address from the FTP server.
(*default: 21*)
- username: Username from the used FTP account.
- password: Password from the used FTP account.
- path: Name of the directory on the FTP server.
- connection test: Test for the specified settings.

Important:

Please note that usually a connection to a FTP server via the internet or LTE needs a enabled passive mode.

When you click on the button “start test” you can execute the FTP connection test. Therefore it’s necessary to save the settings before you do the test. After clicking on the button a pop up will open in which you can see a detailed expiration of the connection.

```
Webserver - EtherSens - Mozilla Firefox
192.168.1.58/service/ftp-test.htm

Info: Bound data socket to remote port 53561
Server: 227 Entering Passive Mode (192,168,1,69,209,57)
Client: RETR test.txt
Server: 150 Opening data channel for file download from server of "/Pi/test.txt"
Info: Connected data socket to server on local port 50278
Info: Data socket closed
Server: 226 Successfully transferred "/Pi/test.txt"

FTP test RNFR + RNT0:
Client: RNFR test.txt
Server: 350 File exists, ready for destination name.
Client: RNT0 newtest.txt
Server: 250 file renamed successfully

FTP test LIST:
Client: TYPE I
Server: 200 Type set to I
Info: Opening data socket to 192.168.1.69
Client: PASV
Info: Bound data socket to remote port 59721
Server: 227 Entering Passive Mode (192,168,1,69,233,73)
Client: LIST
Server: 150 Opening data channel for directory listing of "/Pi"
Info: Connected data socket to server on local port 55367
Info: Data socket closed
Server: 226 Successfully transferred "/Pi"

FTP test DELE:
Client: DELE newtest.txt
Server: 250 File deleted successfully
```

With the help of the connection test you can test the connection and detect errors in your configuration. At the connection test many of the FTP commands that are used by the EtherSens are used. Beside the basic commands *USER*, *PASS*, *CWD*, *TYPE*, *PORT*, *PASV* and *QUIT* EtherSens is using the commands *RNFR*, *RNT0*, *DELE*, *SIZE*, *STOR*, *APPE*, *RETR*, *LIST* and *ABOR* for the data transfer and connection control.

Important:

If a FTP transfer is running at the moment (e. g. throw a recording) it can happen that the FTP test will fail. In such a situation it may be helpful to disable the FTP recording for the moment. After you are finished with testing you can enable the recording again.

It is necessary to save the settings via the “save” button before you execute the test transfer.

4.3.7.2 Menu item file manager

<input type="checkbox"/>	file name	change date	file size	action
<input type="checkbox"/>	config.akt	24.10.2016 09:46:28	2 KB	📄 📁 ✎ —
<input type="checkbox"/>	processlist.akt	24.10.2016 09:46:30	14 KB	📄 📁 ✎ —

No file selected.

The menu item “file manger” can be found as a sub item of the menu item “storage”. In the file manager you can view and manage your files on the local storage medias (SD card and USB stick) and on the FTP server (if specified). Therefore you have the following icons on the right side of each line which represents a file on the media:

- 📄 file download to the PC (*only for SD card and USB stick*)
- 📁 file transfer to the FTP server (*only for SD card and USB stick*)
- 📄 file transfer to the SD card (*only for FTP server*)
- ✎ rename file (*When you click at the icon a pop up will open in which you can enter the new name.*)
- delete file

Furthermore it’s possible to delete multiple files with a single button click. Therefore you need to select all files which should be deleted with the help of the checkboxes. A click to the checkbox on the head line marks all files. A second click removes the marks from all files. After marking the files and clicking on the button “Delete selected files” all files which were marked will get deleted.

Hint:

Please note that during an active SD recording the recording files (e. g. history.bin) can't be transmitted to the PC or the FTP server.

If you want to upload a file from your PC to one of the local storage medias (SD card or USB stick) of your EtherSens device, you can select a file from your PC after clicking on the button “Browse...”. After the upload process was started a progress bar will be visible which shows the state of the upload.

If a file with the same name already exists on the SD card or on the USB stick, a pop up window will be shown. Now you can specify if the file on the media should be overwritten or if you want to abort the upload process.

With the button “format” you can format the plugged in storage media (with FAT). Thereby all files on the storage media are getting deleted. This function isn't available on the file manager for the FTP server.

A click on the  icon will refresh the file list. This action will be automatically performed after e. g. renaming or deleting a file.

4.4 Menu item process

general	
state:	processing values
history export:	transfer is not running
Joint file state:	inactive

process values				
Index	name	state	error state	file state
0	Spannung L1 (rms)	computer value	no error	inactive
1	Spannung L2 (rms)	computer value	no error	inactive
2	Spannung L3 (rms)	computer value	no error	inactive
3	Strom L1 (rms)	computer value	no error	inactive
37	ACCMODE	initialization	no error	inactive

limit values			
Index	formula	state	counter / time
there are no data to view			

PLC messages				
Index	state	error state	transfer state	data counter
there are no data to view				

RFC1006 client						
Index	network interface	local ip address	local port	remote ip address	remote port	state
there are no data to view						

RFC1006 server						
Index	network interface	local ip address	local port	remote ip address	remote Port	state
0	WLAN	192.168.1.58	102	-	-	wait for connection
	LAN	192.168.1.59				
1	WLAN	192.168.1.58	102	-	-	wait for connection
	LAN	192.168.1.59				
2	WLAN	192.168.1.58	102	-	-	wait for connection
	LAN	192.168.1.59				
3	WLAN	192.168.1.58	102	-	-	wait for connection
	LAN	192.168.1.59				
4	WLAN	192.168.1.58	102	-	-	wait for connection
	LAN	192.168.1.59				
5	WLAN	192.168.1.58	102	-	-	wait for connection
	LAN	192.168.1.59				

TCP process server						
Index	network interface	local ip address	local port	remote ip address	remote Port	state
0	WLAN	192.168.1.58	65535	-	-	wait for connection
	LAN	192.168.1.59				

On this page you can see some status information for your process list (devices, process values, limit values, PLC messages and DB backup/restore). The image above shows the content of the process page on factory default of a EtherSens Energy device (*version 1.24; truncated*).

The menu item “process” contains some sub items:

- devices
- process values
- calculations
- limit values
- PLC messages
- message settings
- DB backup/restore

On all of these pages the sensors and measure values can be configured. Changing the configuration is only possible when you are logged in on the web server. Without logging in the configuration can only be viewed. Some advanced settings can only be changed from the expert or master user. The settings on the above named pages affects the configuration which is named “process list” in the following topics.

4.4.1 Menu item devices

The menu item “devices” contains the following sub items: “client”, “server” and “couplings”. The menu points are described on the following pages. If you click on the menu item “devices” you will be redirected to the sub menu item “client”.

4.4.1.1 Menu item client

name	interface	module	address	sensor type	aux address
Energy	I2C	2	0x38	Energy	0x00
Plant 1	RFC 1006	<input checked="" type="radio"/> LAN	192.168.1.94	0	2
	EtherSens	<input checked="" type="radio"/> WiFi			

In this menu item you can configure and add devices (sensors, inputs / outputs, RFC1006 connections, EtherSens couplings, Modbus slaves) which are connected to the EtherSens device.

Important:

The communication to the build in sensors, inputs and outputs are running with the I2C bus. From factory default the I2C devices are all configured and changes are not needed. I2C devices can only edited (except the name), deleted or added by the master user and by the support staff of your distribution partner. But such type of changes should only be done together with the technical support.

name: A free definable name which should be used for the device.

interface: The interface type for the communication which should be used (I2C, EtherSens, RFC1006, Modbus).



module:	Number of the I2C module which should be used (only for I2C).
network interface:	Selection of the network interface (only for EtherSens and RFC1006).
slave no.:	Address of the device (only for Modbus).
address:	Address of the sensor (only for I2C).
IP address:	IP address of the network device (only for EtherSens and RFC1006).
sensor type:	Type of the sensor (also see list below, only for I2C).
rack:	Rack value of the PLC (only for RFC1006). <i>(default: 0)</i>
aux address:	Help address for the sensor (only for I2C).
slot:	Slot value of the PLC (only for RFC1006). For S7-400 PLCs with double wide power supplies the slot value is 3, for single wide power supplies the value is 2 as well as for S7-300 PLCs. <i>(default: 2)</i>

The following I2C addresses are currently in use:

0x1D	Accelerometer (ADXL3xx)
0x20 - 0x22	Digital-IO (TCA9534)
0x23 - 0x25	Reserved for future Digital-IO (TCA9534)
0x26	Relay-IO (TCA9534)
0x27	Measurement switching for Analog-In-Card HW 1.1
0x28	Temperature sensor (HYT)
0x29	Light sensor (TSL4531)
0x38	Energy
0x48	Analog-In (ADS1115/ADS1115+)
0x49 – 0x4B	Reserved for future Analog-In (ADS1115/ADS1115+)
0x4C	Analog-Out (DAC6574)
0x4D – 0x4F	Reserved for future Analog-Out (DAC6574)
0x70 – 0x71	4x14 segment view (HT16K33)
0x72 – 0x75	Reserved for future 4x14 segment view (HT16K33)

- 0x76 Temperature sensor (BME280)
- 0x77 Reserved for future temperature sensor (BME280)

If you set up a EtherSens coupling this will use the RFC1006 protocol (TCP port 102) internally. This device type was only added to provide a more simple set up for you.

If you want to add a new device you have to fill in the last line and click on the -icon afterwards. With the symbol  an existing device can be deleted again. Furthermore the order of devices can be changed by clicking on the arrow symbols.







For the I2C sensor “Energy” which is integrated in all Energy devices as well as the **MONI** the symbol  is shown on the corresponding device entry additionally. With this symbol you can open the calibration manager, where you can backup and restore the calibration data for all current values of the sensor. The data gets stored in text files on the SD card with a freely definable name. Managing multiple calibration data can be useful if you use the device e. g. depending on the place of use with different folding-cores or Rogowski coils. The backup and restore function is as the calibration of single values only available for the user expert or master. After you have clicked on the symbol within the device entry, the following window will appear:

Energy calibration backups

new backup

file name: .ecb save calibration

existing backups 

file name	change date	file size	
Adjustment manual.ecb	19.11.2020 15:32:50	1 KB	 
Developer board.ecb	20.11.2020 09:48:02	1 KB	 
Rogowski test setup.ecb	19.11.2020 15:34:42	1 KB	 

On the upper part of the dialog you store the actual calibration from the current values of the device. Therefore you have to enter a unique name into the text field and click on the button “save calibration”. Afterwards a

backup with the corresponding data and entered name gets written to the SD card.

In the second part of the dialog you can see all available files with calibration data. With the symbol — you can remove a previously created calibration backup. If you want to restore the calibration data from a specific file you have to click on the symbol ↗ of the corresponding entry. Now the file gets read in and the data will be directly submitted and stored in the device.

Important:

After changes in the selection lists input fields as well as after changing the order or adding or deleting a device the configuration must be saved with the “save” button.

Hint:

A maximum of 30 devices can be added and configured.

4.4.1.2 Menu item server

server devices	
port RFC1006 server 1:	102
port RFC1006 server 2:	102
port RFC1006 server 3:	102
port RFC1006 server 4:	102
port RFC1006 server 5:	102
port RFC1006 server 6:	102
port TCP process server 1:	65535

On this page you can specify the settings for the server devices:

- port RFC1006 server x: Specifies the port of the respective server (currently 6 servers are available)
(default 102)
- port TCP process server x: Specifies the port of the respective server (currently 12 servers are available).
(default 65535)

4.4.1.3 Menu item couplings

On this menu item you can configure different device couplings. The description of the couplings can be found in the chapter “Device couplings” of this manual. In the current section the configuration parameters of the couplings are described only.

PLC socket coupling	
enable:	<input type="checkbox"/> enable SPS socket coupling
PLC connection:	Plant 1
operand PLC source:	flag (F)
DB number PLC source:	0
address PLC source:	100
length PLC source:	1
operand PLC target:	flag (F)
DB number PLC target:	0
address PLC target:	101
length PLC target:	1
TCP port:	65534
close TCP socket:	<input type="checkbox"/> close TCP socket after successful transfer
polling time:	1s

The following parameters are available for the PLC socket coupling:

enable:	Determines if the coupling is used.
PLC connection:	The connection to the PLC, which should be used for the coupling.
operand PLC source:	The type of the source area in the PLC.
DB number PLC source:	The number of the data block of the source area in the PLC.
address PLC source:	The start address of the source area in the PLC.
length PLC source:	The length of the data in the source area in the PLC.
operand PLC target:	The type of the target area in the PLC.
DB number PLC target:	The number of the data block of the target area in the PLC.
address PLC target:	The start address of the target area in the PLC.
length PLC target:	The length of the data for the target area in the PLC.
TCP port:	The TCP port which should be used for the coupling.

close TCP socket:

Determines if the TCP socket should be close after a transfer.

polling time:

Specifies the time interval for checking the source or target area.

4.4.2 Menu item process values

The menu item “process values” contains a page for configuring all process values (measured values) of the device. The configuration is limited depending on the logged in user type. The image below shows the factory defaults for the EtherSens Energy device (*truncated*).

#	sampling rate	name	chart color	change checking	record	view web	
0	1s	Voltage L1 (rms)		<input type="checkbox"/>	<input type="checkbox"/>	<input checked="" type="checkbox"/>	✖ ↗ ↘ ↙ ↕
1	1s	Voltage L2 (rms)		<input type="checkbox"/>	<input type="checkbox"/>	<input checked="" type="checkbox"/>	✖ ↗ ↘ ↙ ↕
2	1s	Voltage L3 (rms)		<input type="checkbox"/>	<input type="checkbox"/>	<input checked="" type="checkbox"/>	✖ ↗ ↘ ↙ ↕
3	1s	Current L1 (rms)		<input type="checkbox"/>	<input type="checkbox"/>	<input checked="" type="checkbox"/>	✖ ↗ ↘ ↙ ↕
4	1s	Current L2 (rms)		<input type="checkbox"/>	<input type="checkbox"/>	<input checked="" type="checkbox"/>	✖ ↗ ↘ ↙ ↕
5	1s	Current L3 (rms)		<input type="checkbox"/>	<input type="checkbox"/>	<input checked="" type="checkbox"/>	✖ ↗ ↘ ↙ ↕
33	1s	Line frequency		<input type="checkbox"/>	<input type="checkbox"/>	<input checked="" type="checkbox"/>	↗ ↘ ↙ ↕
34	1s	Current N-line		<input type="checkbox"/>	<input type="checkbox"/>	<input checked="" type="checkbox"/>	✖ ↗ ↘ ↙ ↕
35	disabled	GAIN		<input type="checkbox"/>	<input type="checkbox"/>	<input type="checkbox"/>	↗ ↘ ↙ ↕
36	disabled	CONFIG		<input type="checkbox"/>	<input type="checkbox"/>	<input type="checkbox"/>	↗ ↘ ↙ ↕
37	disabled	ACCMODE		<input type="checkbox"/>	<input type="checkbox"/>	<input type="checkbox"/>	↗ ↘ ↙ ↕
	disabled			<input type="checkbox"/>	<input type="checkbox"/>	<input type="checkbox"/>	+

In the list the following basic settings can be changed:

- sampling rate:** The sampling rate for the process value. When clicking on it a pop up window gets displayed in which it also can be disabled.
- name:** The name of the process value. This name is free definable but have to be unique.
- chart color:** The color which should be used in the chart.
- change checking:** Determines if the value should be checked for changes. When the storage kind “combined” is used, the process value, if its get recorded, can trigger a storing. Otherwise when the storage kind “separated” is used, the value gets recorded only, if the value has changed.
- record:** Determines if the value should be recorded to one or multiple storage media(s).
- view web:** Determines if the value should be display on the page “current and history”.

On the process value page there are the icons ↑ and ↓ on each line which can be used to change the order of the process values. This order will be shown at the start page for the current values and is used as order in the record file for all values (storage type combined).

If you want to add a new value you can fill in the last line and click on the + -icon. For deleting a existing value you can use the symbol —.

If you want to add a value you have to chose the device to which the value belongs. Therefore a pop up window with a selection list is shown. In this list only the entries “system”, “internal” and if available the entered RFC1006, EtherSens and Modbus devices are shown.

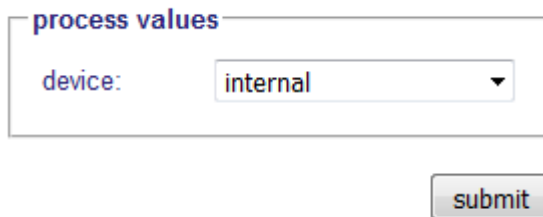

The image shows a web form with the title "process values" in blue text. Below the title is a label "device:" followed by a dropdown menu. The dropdown menu currently displays "internal" and has a small downward-pointing arrow on its right side. Below the form is a rectangular button with the text "submit" in a light gray font.

If you are logged in as a expert or master user after clicking on the “submit” button a second pop up for the advanced settings will be displayed.

System values are special values (e. g. the current time or the SD card state) which are offered from each EtherSens device. Internal values are free definable and are used for calculations (see menu item “calculations”).

The ⚙-symbol allows you to change the advanced configuration. This configuration is only available for the users expert and master. Please note, that not all process values have advanced configurations.

When clicking on the icon ⚙ the pop up window for the calibration will be viewed. This feature is also not available for the basic user.

The pop up window for the advanced configuration and calibration are different from device type to device type. For the calibration a general pop up is available also. The pop ups are explained on the next pages.

If you have a process value which has set the PF (power fail) bit, to save the cumulated value after a restart or power failure, you will see the ⚡ icon. With this icon you can set the power fail value to 0. This is useful e. g. if you have a energy value which should be cleared.

Important:

After changes in the list or in one of the pop ups as well as after changing the order, adding a value or deleting a value the configuration must be saved with the “save” button.

Hint:

A maximum of 150 process values can be added and configured.

4.4.2.1 Advanced settings for Energy

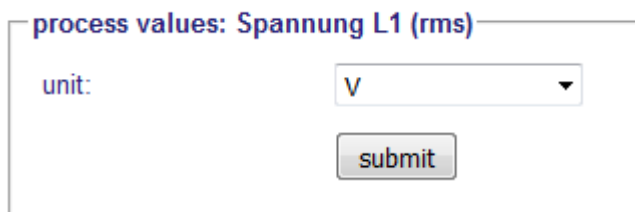

The screenshot shows a configuration window titled "process values: Spannung L1 (rms)". Inside the window, there is a label "unit:" followed by a dropdown menu currently displaying "V". Below the dropdown menu is a "submit" button.

unit: Selection of the unit. The necessary calculation configuration will be set automatically. The list of the units are different from process value to process value (e. g. mV, V and kV for voltages or mA, A and kA for currents).

Important:

On the energy process values the power fail bit is set internally in the process list, to allow that the values are stored over a restart. This functions needs a recording on the SD card!

4.4.2.2 Advanced settings for Analog-In (HW 1.0)

process values: Analog-In 1

differential:	<input type="checkbox"/> to Aln2
range:	0-6.144V ▼
sampling rate ADC:	balanced ▼
minimum value:	0
maximum value:	6.144

submit

- differential:** Enables the differential measurement (from Aln1 to Aln2 and from Aln3 to Aln4). If disabled the inputs will be measure to GND.
- range:** The voltage range in which the inputs should be measured:
0-6.144V, 0-4.096V, 0-2.048V, 0-1.024V, 0-0.512 V or 0-0.256 V for measures to GND
 $\pm 6.144V$, $\pm 4.096V$, $\pm 2.048V$, $\pm 1.024V$, $\pm 0.512V$ or $\pm 0.256V$ for differential measurements
- sampling rate ADC:** Indicates how fast the sampling process should be executed. We recommend choosing a slow sampling for the ADC when you're process value is also sampled slow. Therefore you get a more exact value.
- minimum value:** The minimum value (at 0V) which is used for calculating the final resulting value.
- maximum value:** The maximum value (at full scale) which is used for calculating the final resulting value.

4.4.2.3 Advanced settings for Analog-In (HW 1.1)

process values: Analog-In 1

differential:	<input type="checkbox"/> to Ain2
range:	0-50 V ▼
sampling rate ADC:	balanced ▼
minimum value:	0
maximum value:	0

submit

- differential:** Enables the differential measurement (from Ain1 to Ain2 and from Ain3 to Ain4). If disabled the inputs will be measure to GND.
- range:** The voltage range in which the inputs should be measured:
0-50 V, 0-40 V, 0-20 V, 0-10 V, 0-5 V, 0-4 V, 0-2 V, 0-1V, 0-0.5 V, 0-0.25 V, 0-20 mA or 4-20 mA for measures to GND
 ± 50 V, ± 40 V, ± 20 V, ± 10 V, ± 5 V, ± 4 V, ± 2 V, ± 1 V, ± 0.5 V or ± 0.25 V for differential measurements
- sampling rate ADC:** Indicates how fast the sampling process should be executed. We recommend choosing a slow sampling for the ADC when you're process value is also sampled slow. Therefore you get a more exact value.
- minimum value:** The minimum value (at 0V) which is used for calculating the final resulting value.
- maximum value:** The maximum value (at full scale) which is used for calculating the final resulting value.

4.4.2.4 Advanced settings for Analog-Out

process values: Analog-Out 1

output current:

minimum value:

maximum value:

- output current: Selection of the current range which should be outputted.
- minimum value: The minimum value (at 0 mA or 4 mA) which is used for calculating the final resulting value.
- maximum value: The maximum value (at 20 mA) which is used for calculating the final resulting value.

4.4.2.5 Advanced settings for Digital-IO

process values: Digital-IO 1

I/O:

- I/O: Indicates if the digital pin is an input or an output.

4.4.2.6 Advanced settings for LED segment

process values: LED segment 1

format:

- format: The format in which the value should be shown (float, binary, bool, decimal, hexadecimal, character, counter, timer, binary 16 bit, binary 32 bit, scientific).

4.4.2.7 Advanced settings for accelerometer

The following settings are available for the process value of each axis (X, Y and Z):

process values: X axis

unit:

unit: Selection of the unit. The necessary calculation configuration will be set automatically.

With the help of the configuration process value (process value which has the name “ADXL3 config” by default) settings which belongs to all axis can be changed:

process values: ADXL3 config

sensor:

full resolution:

range:

sensor: Selection of the sensor which is used (ADXL312/313/350).

full resolution: Specifies if the full resolution of 10 to 13 bit or a fixed 10 bit resolution should be used.

range: Selection of the range in which the sensor should measure.

4.4.2.8 Advanced settings for light sensors

process values: Brightness

measuring range:

measuring range: Selection of the range in which the sensor should measure. Please note, that selecting a taller range causes a lower accuracy.

4.4.2.9 Advanced settings for temperature sensor

process values: Temperature

unit:

unit: Selection of the unit. The necessary calculation configuration will be set automatically. The list of the units are different from process value to process value (°C, °F and K for temperature or Pa and hPa for pressure).

4.4.2.10 Advanced settings for PLC values

process values: PLC value

register:

format:

sign:

type:

power fail value:

register: Here you can specify the value (flag, input, output, timer, counter, data block) in S7 notation.

- format: The format in which the value should be shown (float, binary, bool, decimal, hexadecimal, character, counter, timer, binary 16 bit, binary 32 bit, scientific).
- sign: Determines if the value has a sign. If this setting is disabled the value gets interpreted as unsigned.
- type: Indicates if the value should be read or written.
- power fail value: Determines if the process value should be saved at power breaks (helpful for cumulative values).

The format type counter and timer were only added for the PLC values. This is necessary because the S7 counters and timers have a special format. If you read or write S7 counters or timers we recommend to select the respective type. If you do calculations on timers the calculation value must be specified in milliseconds.

If you are not familiar with the S7 notation you can click on the -icon behind the register field. After clicking on the icon a pop up window (see below) should be shown. In the window you can enter the components from the register value (type, DB number, data size, number and bit number) separately. Clicking on “submit” put these values together and writes it into the main window.

process values

type:

DB number:

size:

number:

bit number:

The submitting of the settings from the register pop up above would create the following register value: DB2.DBX4.6

Important:

If the value should be protected against power breaks the process value have to be recorded, because the last value from the history file is used for restoring after a restart.

4.4.2.11 Advanced settings for EtherSens values

process values: voltage L1 (rms)

value:

format:

type:

register: Here you can choose the value from the EtherSens device.

format: The format in which the value should be shown (float, binary, bool, decimal, hexadecimal, character, counter, timer, binary 16 bit, binary 32 bit, scientific).

type: Indicates if the value should be read or written.

4.4.2.12 Advanced settings for Modbus values

process values: digital output

table:

address:

size:

format:

type:

power fail value:

table: The table in which the value is placed.

address: The address of the value (without table-number, 0-based)

size: The amount of bits which should be read or write.

format: The format in which the value should be shown (float, binary, bool, decimal, hexadecimal, character, counter, timer, binary 16 bit, binary 32 bit, scientific).

type: Indicates if the value should be read or written.

power fail value: Determines if the process value should be saved at power breaks (helpful for cumulative values).

4.4.2.13 Advanced settings for system values

The screenshot shows a web form titled "process values: time". It contains two dropdown menus. The first is labeled "reference value:" and is set to "system time". The second is labeled "format:" and is set to "decimal". Below these dropdowns is a "submit" button.

reference value: The system value which should be read (see list below).

format: The format in which the value should be shown (float, binary, bool, decimal, hexadecimal, character, counter, timer, binary 16 bit, binary 32 bit, scientific).

The following system values are available:

- system time: The system time as second value since 01.01.1970 (UNIX timestamp).
- WiFi online timestamp: The timestamp from the last WiFi connection process as second value since 01.01.1970 (UNIX timestamp).
- LAN online timestamp: The timestamp from the last LAN connection process as second value since 01.01.1970 (UNIX timestamp).
- RTC running bit:
 - 0 = RTC not running
 - 1 = RTC running
- SD card state:
 - 0 = SD card isn't available
 - 1 = SD card was logged out via the web page

- 2 = SD card is used via the USB interface
- 255 = SD card is available and function
- SD record state:
 - 0 = recording not running
 - 1 = recording running
 - 2 = error while writing the data
 - 3 = no data available for recording
- SD full size (KB): Total size of the SD card in kilobyte.
- SD free size (KB): Free size of the SD card in kilobyte.
- FTP record bit:
 - 0 = recording not running
 - 1 = recording running
- error bits (*same as flashing codes*):
 - bit 0: Initialization error of a sensor
 - bit 1: Space on the SD card smaller than 1kilobyte or SD card removed without logging it out
 - bit 2: Error at last mail transfer (SMTP)
 - bit 3: Error at last time adjusting (NTP)
 - bit 4: No network connection available (only when there isn't a connection to the Access Point and no LAN link state available)
 - bit 5 - 7: not used
- warning bits (*same as warning view on the web page*):
 - bit 0: Configuration not saved yet.
 - bit 1: Calibration is running.
 - bit 2: Calibration configuration not saved yet.
 - bit 3: Calculation index invalid (*only if expert page was used*).
 - bit 4: Memory overflow while recording (*sampling rate or recording to fast*).
 - bit 5: Firmware update is running.
 - bit 6: Memory overflow while sending a limit message.
 - bit 7: Old limit values found in the configuration.
 - bit 8: System time was not initialized correctly yet.

- bit 9: Sampling rate of process values were getting adjusted (*can happen at too fast sampling*).
- bit 10: SD card too small or rather history buffer too big.
- bit 11: History files on the SD card are getting initialized.
- bit 12: History backup files on the SD card are getting created.
- bit 13: History backup files needing too much space.
- bit 14: Too many history backup files found.
- bit 15: Cable break on analog input.
- bit 16: Export of history data is running.
- bit 17: An invalid socket reference was detected.
- bit 18: An invalid write access to the SD card was detected.
- bit 19 - 31: not used
- SD CSV record bit:
 - 0 = recording not running
 - 1 = recording running
- USB stick state:
 - 0 = USB stick isn't available
 - 1 = USB stick was logged out via the web page
 - 255 = USB stick is available and function
- USB record bit:
 - 0 = recording not running
 - 1 = recording running

4.4.2.14 Advanced settings for internal values

process values: counter

reference value:  counter

format: hexadecimal

unit:

write: allow

power fail value:

reference value: The value to which the process value is referencing or a constant. You can also reference to the process value self. You have to enter a value with a contraction:

x12AB = hexadecimal

i123 = decimal

f12.34 = float

b00101101 = binary

By clicking on the -icon you can swap between a input field and a drop-down-list with the process values.

format: The format in which the value should be shown (float, binary, bool, decimal, hexadecimal, character, counter, timer, binary 16 bit, binary 32 bit, scientific).

write: Determines if the value can be written on the page “current and history”.

power fail value: Determines if the process value should be saved at power breaks (helpful for cumulative values).

Important:

If the value should be protected against power breaks the process value have to be recorded, because the last value from the history file is used for restoring after a restart.

Internal values are used for calculations. To define or modify calculations please use the page “calculations” under the menu item “process”. The process value page should only be used for

changing settings like unit, chart color, record, view web and power fail, because these settings are missing on the calculations page.

4.4.2.15 Calibration for Energy

calibration: Strom L1 (rms)

primary:	secondary:
<input type="text" value="500.000"/> A	<input type="text" value="0.048"/> V

For energy devices voltage and current values can be calibrated. For calibrating voltage values you will directly get the general calibration pop up. If you want to calibrate current values you have to set up the relation between the primary and secondary side first. Therefore you have to enter the primary current and the secondary current or rather the secondary voltage. The values are saved in the configuration and set from factory default. The image shows the calibration pop up for current values (device type Rogowski coil).

- primary: The maximum current who flows on the primary side.
- secondary: The maximum current who flows on the secondary side (for folding-cores) or rather the maximum voltage which is outputted (for Rogowski coils).

4.4.2.16 Calibration for accelerometer

calibration: ADXL3 config

X axis:	0.13
Y axis:	0.26
Z axis:	1.35

If you want to calibrate an accelerometer (ADXL3xx) you have to find the configuration process value (default name “ADXL3 config”) and click on the calibration symbol in the process list.

In the calibration pop up you can see the current values of all axis. By clicking on the button “set zero point” the offset of all values will be written to the configuration. The offset value will be used to calculate the values which are shown. If necessary you can execute the zero point adjustment multiple times. After you have finished the calibration you can close the pop up. Furthermore you have to save the settings in the main window via the “save” button.

4.4.2.17 Calibration (general)

calibration			
zero value adjustment	0.00	adjust	↑ ↓
full scale adjustment:	<input type="text"/>	adjust	↑ ↓
current value:	0.00	✓	✗

With the help of the (general) calibration pop up you can executed a zero point and full scale adjustment. The resulting offset and the gradient is calculated automatically, stored in the configuration and used for calculating the viewed value.

The first line is used for the calibration of the zero point. Therefore in this line the fixed value 0.00 is shown. After you have applied the zero value (for analog inputs 0V) you can click on the button “adjust”. After that the current value (last line) should be 0.00 in ideal case. If you want to do some small adjustments you can use the arrow icons.

The second line is used for the full scale adjustment. To do this you should apply the maximum value (for analog inputs 50V when using the configuration 0-50V) in ideal case. Then enter the applied voltage, current or value in the text box and click on “adjust”. If wished you can to adjustments with the arrow icons here as well as for the zero point adjustment.

If you have finished your calibration you can click on the ✓-icon to submit the calibration values. Closing the window or clicking on the symbol ✗ restores the old calibration values.

The following devices / values are supporting the zero point adjustment:

- Analog In (HW1.1)

The following devices / values are supporting the full scale adjustment:

- Energy: only voltage and current inputs
- Analog In (HW1.1)

4.4.2.18 Page expert mode

The page “expert mode” is a sub item of the menu “process values”. The page can only be viewed by the master user.

On this page the values can also be moved, deleted and added. Clicking on the ✖-icon starts the calibration. But before that the configuration fields for the calibration must be filled in and saved. The button “calibrate all process values” sets a values to the calibration mode.

process value		process value										calibration				auto calibration						
en	nm	dev	reg	typ	calc	calcp	fmt	u-t	s-r	col	io	pf	cc	rec	web	creg	ctyp	cval	ccal	cmin	cmax	cnom
<input checked="" type="checkbox"/>	Voltage L1 (rms)	Energy	xe43c1	4	104	i10000	float	V	1000		<input checked="" type="checkbox"/>	<input checked="" type="checkbox"/>	<input checked="" type="checkbox"/>	<input checked="" type="checkbox"/>	<input checked="" type="checkbox"/>	4381	3	x0ff8e997	4	0.5	5600000	2300000
<input checked="" type="checkbox"/>	Voltage L2 (rms)	Energy	xe43c3	4	104	i10000	float	V	1000		<input checked="" type="checkbox"/>	<input checked="" type="checkbox"/>	<input checked="" type="checkbox"/>	<input checked="" type="checkbox"/>	<input checked="" type="checkbox"/>	4383	3	x0ff8e997	4	0.5	5600000	2300000
<input checked="" type="checkbox"/>	Voltage L3 (rms)	Energy	xe43c5	4	104	i10000	float	V	1000		<input checked="" type="checkbox"/>	<input checked="" type="checkbox"/>	<input checked="" type="checkbox"/>	<input checked="" type="checkbox"/>	<input checked="" type="checkbox"/>	4385	3	x0ff8e997	4	0.5	5600000	2300000
<input checked="" type="checkbox"/>	Current L1 (rms)	Energy	xe43c0	4	104	i1000	float	A	1000		<input checked="" type="checkbox"/>	<input checked="" type="checkbox"/>	<input checked="" type="checkbox"/>	<input checked="" type="checkbox"/>	<input checked="" type="checkbox"/>	4380	3	x0f8e0e96	6	0.048	500000	0
<input checked="" type="checkbox"/>	Current L2 (rms)	Energy	xe43c2	4	104	i1000	float	A	1000		<input checked="" type="checkbox"/>	<input checked="" type="checkbox"/>	<input checked="" type="checkbox"/>	<input checked="" type="checkbox"/>	<input checked="" type="checkbox"/>	4382	3	x0f8e0e96	6	0.048	500000	0
<input checked="" type="checkbox"/>	Current L3 (rms)	Energy	xe43c4	4	104	i1000	float	A	1000		<input checked="" type="checkbox"/>	<input checked="" type="checkbox"/>	<input checked="" type="checkbox"/>	<input checked="" type="checkbox"/>	<input checked="" type="checkbox"/>	4384	3	x0f8e0e96	6	0.048	500000	0
<input checked="" type="checkbox"/>	Apparent Power L1	Energy	xe519	8	104	i1000	float	KVA	1000		<input checked="" type="checkbox"/>	<input checked="" type="checkbox"/>	<input checked="" type="checkbox"/>	<input checked="" type="checkbox"/>	<input checked="" type="checkbox"/>	438e	3	x0feab6cc	1	0	0	0
<input checked="" type="checkbox"/>	Apparent Power L2	Energy	xe51a	8	104	i1000	float	KVA	1000		<input checked="" type="checkbox"/>	<input checked="" type="checkbox"/>	<input checked="" type="checkbox"/>	<input checked="" type="checkbox"/>	<input checked="" type="checkbox"/>	438f	3	x0feab6cc	1	0	0	0
<input checked="" type="checkbox"/>	Apparent Power L3	Energy	xe51b	8	104	i1000	float	KVA	1000		<input checked="" type="checkbox"/>	<input checked="" type="checkbox"/>	<input checked="" type="checkbox"/>	<input checked="" type="checkbox"/>	<input checked="" type="checkbox"/>	4390	3	x0feab6cc	1	0	0	0
<input checked="" type="checkbox"/>	Active Power L1	Energy	xe513	8	104	i1000	float	kW	1000		<input checked="" type="checkbox"/>	<input checked="" type="checkbox"/>	<input checked="" type="checkbox"/>	<input checked="" type="checkbox"/>	<input checked="" type="checkbox"/>	4391	3	x0feab6cc	1	0	0	0
<input checked="" type="checkbox"/>	Active Power L2	Energy	xe514	8	104	i1000	float	kW	1000		<input checked="" type="checkbox"/>	<input checked="" type="checkbox"/>	<input checked="" type="checkbox"/>	<input checked="" type="checkbox"/>	<input checked="" type="checkbox"/>	4393	3	x0feab6cc	1	0	0	0
<input checked="" type="checkbox"/>	Active Power L3	Energy	xe515	8	104	i1000	float	kW	1000		<input checked="" type="checkbox"/>	<input checked="" type="checkbox"/>	<input checked="" type="checkbox"/>	<input checked="" type="checkbox"/>	<input checked="" type="checkbox"/>	4395	3	x0feab6cc	1	0	0	0
<input checked="" type="checkbox"/>	Reactive Power L1	Energy	xe516	8	104	i1000	float	KVAR	1000		<input checked="" type="checkbox"/>	<input checked="" type="checkbox"/>	<input checked="" type="checkbox"/>	<input checked="" type="checkbox"/>	<input checked="" type="checkbox"/>	4397	3	x0feab6cc	1	0	0	0
<input checked="" type="checkbox"/>	Reactive Power L2	Energy	xe517	8	104	i1000	float	KVAR	1000		<input checked="" type="checkbox"/>	<input checked="" type="checkbox"/>	<input checked="" type="checkbox"/>	<input checked="" type="checkbox"/>	<input checked="" type="checkbox"/>	4399	3	x0feab6cc	1	0	0	0
<input checked="" type="checkbox"/>	Reactive Power L3	Energy	xe518	8	104	i1000	float	KVAR	1000		<input checked="" type="checkbox"/>	<input checked="" type="checkbox"/>	<input checked="" type="checkbox"/>	<input checked="" type="checkbox"/>	<input checked="" type="checkbox"/>	439b	3	x0feab6cc	1	0	0	0
<input checked="" type="checkbox"/>	Apper Energy L1	Energy	xe40c	1	104	i10	float	KVAh	10000		<input checked="" type="checkbox"/>	<input checked="" type="checkbox"/>	<input checked="" type="checkbox"/>	<input checked="" type="checkbox"/>	<input checked="" type="checkbox"/>	0000	0	x00000000	0	0	0	0
<input checked="" type="checkbox"/>	Apper Energy L2	Energy	xe40d	1	104	i10	float	KVAh	10000		<input checked="" type="checkbox"/>	<input checked="" type="checkbox"/>	<input checked="" type="checkbox"/>	<input checked="" type="checkbox"/>	<input checked="" type="checkbox"/>	0000	0	x00000000	0	0	0	0
<input checked="" type="checkbox"/>	Apper Energy L3	Energy	xe40e	1	104	i10	float	KVAh	10000		<input checked="" type="checkbox"/>	<input checked="" type="checkbox"/>	<input checked="" type="checkbox"/>	<input checked="" type="checkbox"/>	<input checked="" type="checkbox"/>	0000	0	x00000000	0	0	0	0
<input checked="" type="checkbox"/>	Act Energy L1 t	Energy	xe400	1	104	i10	float	kWh	10000		<input checked="" type="checkbox"/>	<input checked="" type="checkbox"/>	<input checked="" type="checkbox"/>	<input checked="" type="checkbox"/>	<input checked="" type="checkbox"/>	0000	0	x00000000	0	0	0	0

The table shows the following configuration fields:

- en: Activates or deactivates the value.
- nm: The name of the process value. This name is free definable but have to be unique.
- dev: The device to which the process value belongs.
- reg: The value which should be requested (register for sensors, operand for RFC1006) or rather the reference value (constant or rather reference for system and internal values).
- typ: The number of the data type (see below).
- calc: The number of the calculation (see below).
- calcp: Value which is used together with the calculation type (set via calc) as a calculation on the raw value.
- fmt: The format in which the value should be shown (float, binary, bool, decimal, hexadecimal, character, counter, timer, binary 16 bit, binary 32 bit, scientific).
- u-t: A free definable text which is used as unit.
- s-r: The sampling rate for the process value.
- col: The color which should be used in the chart.
- io: Determines if the process value is used for reading or writing.

pf:	Determines if the process value should be saved at power breaks (helpful for cumulative values).
cc:	Determines if the value should be checked for changes. When the storage kind “combined” is used, the process value, if its get recorded, can trigger a storing. Otherwise when the storage kind “separated” is used, the value gets recorded only, if the value has changed.
rec:	Determines if the value should be recorded to one or multiple storage media(s).
web:	Determines if the value should be display on the page “current and history”.
creg:	The register in which the calibration value should be written.
ctyp:	The number of the data type for the register value (see below).
cval:	The calibration value (maybe used as second calculation).
ccal:	The number of the calculation for the register value (see below).
cmin:	The minimum value which is used for calculating the final resulting value.
cmax:	The maximum value which is used for calculating the final resulting value.
cnom:	The nominal value which is used for calculating and calibration.

For the settings reg, calcp and cval next to the value a contraction must be entered. The following contractions are available:

x12AB = hexadecimal

i123 = decimal

f12.34 = float

b00101101 = binary

The following table shows all available data types:

no.	name	bit length data	sign	bit length transfer	padding
1	32S	32	signed	32	none
2	32U	32	unsigned	32	none
3	32ZPSE	24	signed	32	MSB
4	32ZP24S	24	signed	32	MSB
5	32ZP24U	24	unsigned	32	MSB
6	32ZP20S	20	signed	32	MSB
7	32ZP20U	20	unsigned	32	MSB
8	32SE	24	signed	32	none
9	16S	16	signed	16	none
10	16U	16	unsigned	16	none
11	16ZP	10	unsigned	16	MSB
12	8S	8	signed	8	none
13	8U	8	unsigned	8	none
14	16ZPL	10	unsigned	16	LSB
15	1U	1	unsigned	8	MSB
16	24ZPL	20	unsigned	24	LSB

The following table shows all available calculations:

number	type	formula
0	none	-
20	angle calculation for ADE78xx in degrees (°)	$x = (x * 360 * 50) / 256000$
21	angle calculation for ADE78xx in cos	$x = \cos((((x * 360 * 50) / 256000) * 2 * \text{Pi}) / 360)$
22	phase frequency calculation for ADE78xx	$x = 256000 / x$

23	angle calculation for ADE78xx in sin	$x = \sin(\frac{(x * 360 * 50)}{256000} * 2 * \text{Pi}) / 360$
40	temperature for HYT	$x = ((x \& 0x3FFF) * (165 / \text{pow}(2, 14))) - 40$
41	humidity for HYT	$x = (x \gg 16) * (100 / \text{pow}(2, 14))$
42	conversion from °C to °F	$x = (x * 1.8) + 32$
100	set value	$x = \text{calcp}$
101	addition	$x = x + \text{calcp}$
102	subtraction	$x = x - \text{calcp}$
103	multiplication	$x = x * \text{calcp}$
104	division	$x = x / \text{calcp}$
105	positive change counter	IF ($\text{calcp} > \text{calcp}^{-1}$) $x++$
106	negative change counter	IF ($\text{calcp} < \text{calcp}^{-1}$) $x++$
107	change calculation	$x = \text{calcp} - \text{calcp}^{-1}$
108	bit-wise left shift	$x = x \ll \text{calcp}$
109	bit-wise right shift	$x = x \gg \text{calcp}$
110	bit-wise And	$x = x \& \text{calcp}$
111	bit-wise Or	$x = x \text{calcp}$
112	bit-wise Exclusive-Or	$x = x \wedge \text{calcp}$
113	modulo (rest of division)	$x = x \% \text{calcp}$
114	subtraction with 10% dead zone	IF ($x < (0.1 * \text{calcp})$) $x = 0$ ELSE $x = x - \text{calcp}$

calcp refers to the entered constant or to the value of the referenced process value.

calcp⁻¹ refers to the previous value of calcp (only relevant for parameter with reference to a process value).

Attention:

The page expert mode allows you to change all settings of all process values. Please use this page only for system values and internal values or in agreement with the support. Wrong settings and values can cause incorrect outputted values and may damage your device.

4.4.3 Menu item calculations

calculations	sampling	name	base	type 1	value 1	type 2	value 2	format	
	1s	temperature	x0000	special	x00000000	none	x00000000	float	—↑↓
	1s	temperature 2	@temperatu	*	f1.8	+	f32	float	—↑↓
	1s	temperature 3	@temperatu	-	f273.15	none	x00000000	float	—↑↓
	disabled		x0000	none		none		float	+

sampling: The sampling rate of the process value. When you click on the time you will get a pop up window. There you can also disable the value.

name: The name of the process values. The name is free definable but only can exist ones.

base: The value to which the process value is referencing. You have to enter a value with a contraction:

x12AB = hexadecimal

i123 = decimal

b00101101 = binary

@Name = reference to another process value (Name)

By clicking on the ⇄-icon you can swap between a input field and a drop-down-list with the process values.

type 1: The first calculation which should be executed.

value 1: The first calculation value which will be needed for the calculation with “type 1” and “base”. You have to enter a value with a contraction:

x12AB = hexadecimal

i123 = decimal

f12.34 = floating point

b00101101 = binary

@Name = reference to another process value (Name)

By clicking on the ⇄-icon you can swap between a input field and a drop-down-list with the process values.

type 2: The second calculation which should be executed.

value 2: The second calculation value which will be needed for the calculation together with “type 2” and the temporarily value from the first calculation. You have to enter a value with a contraction:

x12AB = hexadecimal

i123 = decimal

f12.34 = floating point

b00101101 = binary

@Name = reference to another process value (Name)

By clicking on the ↺-icon you can swap between a input field and a drop-down-list with the process values.

format: The format in which the value should be shown (float, binary, bool, decimal, hexadecimal, character, counter, timer, binary 16 bit, binary 32 bit, scientific).

The complete line (except the columns “sampling”, “name” and “format”) can be read as a formula:

$x = (\text{“base” “type 1” “value 1”}) \text{“type 2” “value 2”}$

If we choose an addition for “type 1” and a multiplication for “type 2” our formula looks like the following:

$x = (\text{“base”} + \text{“value 1”}) * \text{“value 2”}$

The following calculation types are available

- none → The value get not changed.
- = → set calculation value
- + → addition
- - → subtraction
- * → multiplication
- / → division
- positive change counter → The process value gets incremented when the (process) value val1/val2 has a bigger value than before.

- negative change counter → The process value gets incremented when the (process) value val1/val2 has a smaller value than before.
- change calculation → The process value gets assigned the difference value from the (process) value val1/val2 from the current and the last value.
- << → bit-wise left shift
- >> → bit-wise right shift
- & → bit-wise And
- | → bit-wise Or
- ^ → bit-wise Exclusive-Or
- % → modulo (rest of the division)
- - 10% dead zone → If the original value is smaller than 10% of the calculation parameter the process value gets set to 0. Otherwise a normal subtraction will occur.

Important:

The calculation page views all process values. But the reference value can be changed for internal values only. Future the second calculation type and value can be modified for system and internal values only.

4.4.4 Menu item limit values

limit values									
en	value	limit type	limit value	action type	action counter	action	action value	ack	
<input checked="" type="checkbox"/>	temperature	>	f35	counter	0	e-mail	default message	<input type="checkbox"/>	—↑↓
<input type="checkbox"/>	counter	==		counter	0	e-mail	default message	<input type="checkbox"/>	+

- en: Enables or disables the limit checking.
- value: Value which should be monitored (a process value from the device or the current date/time).
- limit type: Comparison of the value with the limit value:
 == → is equal to
 != → is not equal to
 < → is smaller than
 <= → is smaller than or equal to
 > → is bigger than
 >= → is bigger than or equal to
- Cycle for date/time:
 hourly
 daily
 weekly
 monthly
- limit value: For process values this is the limit value for comparison. Therefore you have to enter a value with a contraction:
 x12AB = hexadecimal
 i123 = decimal
 f12.34 = floating point
 b00101101 = binary
 @Name = reference to another process value (Name)
- By clicking on the -icon you can swap between a input field and a drop-down-list with the process values.
- For date/time you can select here to which time the limit value should be triggered.
- action type: counter (frequency till action occurs)
 timer (signal duration till action occurs)
- action counter: for action type: counter: frequency

	timer:	signal duration in seconds
action:	Action which should occur: e-mail, SMS, backup/restore of a DB, writing a process value	
action value:	for action: e-mail:	Selection, if default message or message text should be send (see below)
	SMS:	Selection, if default message or short message should be send (see below)
	backup DB:	DB entry which should be backed up
	restore DB:	DB entry which should be restored
	process value:	Value which should be set (notation same as limit value)
ack:	Specifies if the fault message has to be acknowledged (only for process value limit values with the action "e-mail" or "SMS").	

When you want to trigger actions, this can be a backup of a data block, a e-mail sending or some other actions, on a specific time, you have to select "date/time" as value. Within the selection list "limit type" you can then choose between "hourly", "daily", "weekly" or "monthly" to specify the cycle of the trigger. The corresponding field on the column "limit value" now should show a text, which specifies the time when the action should be triggered. If you want to edit this time, you can simply click on the text. Thereby a pop up window gets opened, which differs a bit depending on the selected cycle (cycle "weekly" was selected for the image below), where you can configure the time.

time picker

day	hour	minute
Monday	8	0

submit

After you have finished your time configuration, you have to click on the button “submit”. The text view within the main window will then be updated. In the example from the image above an action would be triggered on each Monday on 8:00 o'clock.

If you have chosen “e-mail” as action you can click on the text “default message” within the column “action value” to open a pop up window. In this window you can specify own messages with a special receiver e-mail address, subject and content. This messages (named message text) can be used for your limit values and are stored on the SD card. If you look at the pop up window you will see a list of all available messages (no messages are defined yet in the image below):

Messages

No.	receiver mail address	subject	content
<i>Currently there aren't any messages!</i>			

add use default message abort

If you click on the button “add” another pop up window will get opened which shows an editor surface:

messages

mail address: test@example.com

subject: temperature warning

placeholder: use process value placeholder

content: The temperature from plant 2 is too high.

save abort

Within this pop up you can now specify the receiver mail address, the subject as well as the message content.

If you want to fill your message content dynamically with process values, you have to enable the option “use process value placeholder” first. After that you can define a placeholder by typing in the @ character followed by the name of the desired process value (e. g. @Active Power L1) into the message content. When a e-mail gets send this placeholder then will be replaced with current value of this process value. Of course you can also use multiple placeholders within a single message.

When you have finished the definition of your message text, you have to click on the button “save” to save the message on your device. After that the editor window gets closed and the list view gets refreshed.



Now you can click on the ✓-icon to assign the message to your limit value. With the help of the ⚙️-icon you can change the information from your message (e. g. the subject or content) again. When you click at the symbol — the message get deleted permanently.

If you decide to use the default message for your limit value instead you can click on the button “use default message”. Afterwards the default message will be assigned to your limit value and the window gets closed. If you click on this button the message will not be deleted and can be used later or for another limit value.

If you have selected “SMS” as action you will get a window, which looks similar to the window for message texts (e-mail), to define own messages (named short messages). Instead of the fields “receiver mail address” and “subject” you will get the field “telephone number”. The content field is also available here. The usage of placeholders on short messages doesn't have to be enabled explicit and works a bit different as the placeholders on message texts (e-mail). Please read the chapter

“SMS sending an receiving of process values” on this manual for more information.

Important:

If you want to use message texts or short messages you have to plug in a SD card to your device.

Please note that sending SMS may not be free for you. Please check your contract from your SIM card.

The devices of the EtherSens family do not support special characters in SMS to be compatible internationally. So please use letters, numbers, spaces and punctuation marks only.

If you want to add a new limit value just fill in the last row of the table and click on the symbol \oplus . With a click on the \ominus -icon you can delete a limit value. The arrow icons here can be used for changing the order too.

Important:

Please note that after adding, moving or deleting a limit value the configuration is not saved. If you have done your changes please click on the “save” button to save the configuration.

Hint:

A maximum of 25 limit values can be added and configured.

4.4.5 Menu item PLC messages

PLC messages										
en.	PLC	MW control	MW state	com DB	addr.	recv DB	add. info	add. text	polling time	
<input checked="" type="checkbox"/>	Plant 1	<input checked="" type="checkbox"/> 12	14	2	S5 (wor	<input checked="" type="checkbox"/> 4	<input type="checkbox"/>	none	10	— ↑ ↓
<input type="checkbox"/>	Plant 1	<input type="checkbox"/>			S5 (wor	<input type="checkbox"/>	<input type="checkbox"/>	none		+

- en.: Enables the PLC message.
- PLC: The connection which was defined in the device menu.
- MW control: PLC flag word for package control.
(This is only needed if the device is used in replacement of an ASCII-Tele route. This flag allows you a dial to the device. For a basic PLC message this feature is not needed.)
- MW state: PLC flag word for order status.
- com DB: PLC communication DB, in which the data areas for reading and writing are noted.
- addr.: Addressing type of the offset and length field in the PLC communication DB.
(Determines, if the offset and length should be interpreted as words or bytes.)
- recv DB: PLC receiver DB, in which the receiver (e-mail address or telephone number) is noted as S7 string.
(This is only needed if the message should not be sent to the e-mail address which is specified in the mail configuration.)
- add. info: Determines, if the device name and index should be attached to the subject.
(Helpful for identification of the e-mail, format corresponds to reception).
- add. text: Additional text, which should be sent in an e-mail before the content of the PLC.
(Only for sending via e-mail and only with activated license for "PLC messages with additional text".)
- polling time: Time span in seconds, in which the PLC should be polled to check for an order.

Important:

If the setting “additional info” is enabled and the subject together with the subject info is longer than 99 characters, the configured subject get truncated. In this way the subject info remains.

If you have bought a license for the option “PLC messages with additional text” you can see the column “add. text” (as you can also see in the image above). From default “none” is shown, which means that now additional text is attached to the PLC message. If you want to add a new text or choose, edit or delete an existing you can click on the text “none”. Now you should see the following pop-up:

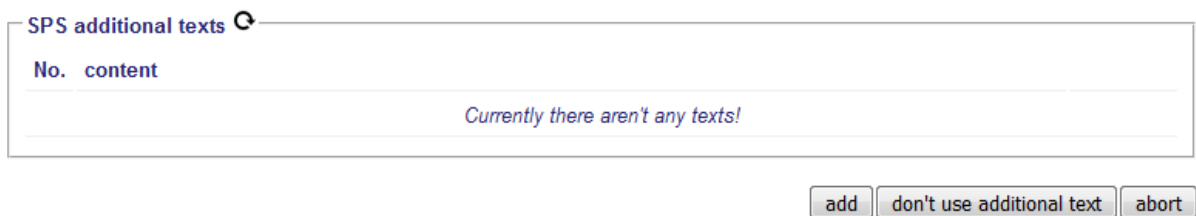

The screenshot shows a window titled "SPS additional texts" with a refresh icon. It contains a table with two columns: "No." and "content". The table is empty, with a message "Currently there aren't any texts!" centered below the header. Below the table are three buttons: "add", "don't use additional text", and "abort".

In this window you can see all available additional texts. On the first call this should be empty because no text was created yet. If you click on the button “add” another window with a text field will be opened:

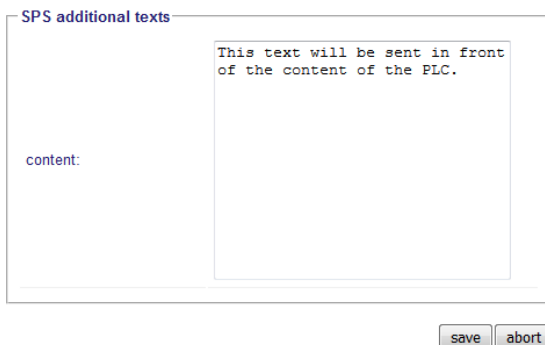

The screenshot shows the "SPS additional texts" window with a text input field. The input field contains the text: "This text will be sent in front of the content of the PLC." Below the input field are two buttons: "save" and "abort".

After you have entered your text you can click on the “save” button. Next the window with the text field disappears and the list view gets refreshed:

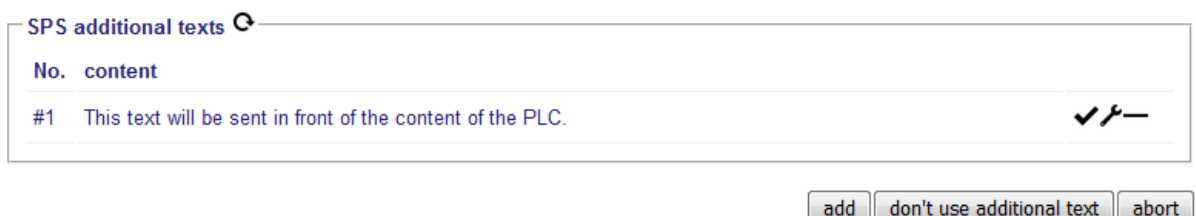

The screenshot shows the "SPS additional texts" window with a refresh icon. The table now contains one row with the following data: "#1" in the "No." column and "This text will be sent in front of the content of the PLC." in the "content" column. To the right of the text in the "content" column are three icons: a checkmark, a pencil, and a minus sign. Below the table are three buttons: "add", "don't use additional text", and "abort".

If you want to assign the created text (or if available another text) to the PLC message you have to click on the symbol ✓. With the help of the icons ✎ and — you can edit or delete an existing text.

If you don't want to use the additional text anymore you can click on the button “don't use additional text”. The defined additional text remains and can't be easily used later for the same or another PLC message.

Important:

For using the additional text option it is necessary to plug in a SD card to your device.

If you want to add a new PLC message just fill in the last row of the table and click on the symbol +. With a click on the —-icon you can delete a PLC message. The arrow icons can be used for changing the order also.

Important:

Please note that after adding or deleting a PLC message the configuration is not saved. If you have done your changes please click on the “save” button to save the configuration.

Hint:

A maximum of 3 PLC messages can be added and configured.

4.4.6 Menu item message settings

message settings

message sending: enabled

process value: Digital-IO 1

times monday: from 00 : 00 to 00 : 00

times Tuesday: from 00 : 00 to 00 : 00

times Wednesday: from 00 : 00 to 00 : 00

times Thursday: from 00 : 00 to 00 : 00

times Friday: from 00 : 00 to 00 : 00

times Saturday: from 00 : 00 to 00 : 00

times Sunday: from 00 : 00 to 00 : 00

save

In this menu item you can configure when your device is allowed to send messages (via e-mail or SMS) which were triggered by a limit value or a recognized PLC message. With the selection list “message sending” you can choose one of the following modes:

- disabled → messages are never sent
- enabled → messages are always sent
- via process value → messages will only be sent if the selected process value has another value than 0
- by schedule → messages will only be sent if the current time of the corresponding weekday is within the specified period

If you have selected the message sending “by schedule” you have the possibility to set a specific period for each weekday in which messages should be sent. First you have to set the check box of the corresponding weekday. Afterwards you can enter the period. The period “from 00:00 to 00:00” ensures that messages will be sent on the whole day. You can also specify a period which goes overnight. The period “from 22:00 to 06:00” will allow messages to be sent between 22 o'clock and 6 o'clock on the following day.

Hint:

Please do also check the parameters for message sending within the menu items “E-Mail” and “USB”.

4.4.7 Menu item DB backup/restore

DB backup/restore							
en.	Name	PLC	data block			storage place	
			number	offset	length		
<input checked="" type="checkbox"/>	data DB	plant 1	100	0	20	SD card	— ↑ ↓
<input type="checkbox"/>		plant 1				SD card	+

- en.: Enables the DB entry.
- Name: Name of the DB entry.
(The name is used for identification purpose and storage of the file on the storage place only).
- PLC: The connection which was defined in the device menu.
- number: The number of the data block.
- offset: The offset in the data block from which data should be backed up or restored.
- length: The length from the area of the data block which should be backed up or restored.
- storage place: Media on which the backup of the area should be stored or loaded.

Important:

The parameters offset and length are, as well as on S7 controllers, byte orientated.

After you have added your RFC1006 device and DB backup/restore entry, you are able to define limit actions to backup and restore the specified data block. This can be done on the page limit values.

The process value and limit value which is used for the action execution can be configured freely (e. g. a digital input or a flag bit from a PLC).

If you want to add a new DB entry just fill in the last row of the table and click on the symbol **+**. With a click on the **—**-icon you can delete a DB entry. The arrow icons can be used for changing the order also.

Important:

Please note that after adding or deleting a DB backup/restore entry the configuration is not saved. If you have done your changes please click on the “save” button to save the configuration.

Hint:

A maximum of 3 DB entries can be added and configured.

4.5 Menu item log in

The device has no device password from factory default. To change the configuration of your device you have to log in with an “empty” password on the page “log in”.



The screenshot shows a web interface for logging in. It features a label "log in" above a "password:" input field. To the right of the input field is a button labeled "log in".

After you have clicked on the button “log in” you will see the following message block.



The screenshot shows a green notification bar at the top with a white checkmark icon and the text "Successfully logged in! EtherSens". Below the notification bar is a navigation menu on the left with items: "current and history", "fault messages", "system", and "general". The "general" item is selected. The main content area shows a table with the following data:

general	
actual time:	18.05.2017 - 09:50:38 (summer time)
product name:	EtherSens
device name (MPLC name):	EtherSens

Now you can change the configuration of your device.

The EtherSens device has three different users with different permissions. From default all users have no password. The following users are available:

- user: Changes for the complete user configuration (except the network configuration) as well as for limit values, PLC messages and limited to devices and process values are possible.
- expert: same as user as well as authorization for changing the network configuration and advanced configuration and calibration for process values
- master: same as expert as well as other permissions

The passwords for all users can be changed on the page “change password”. If multiple users have the same password you will always get logged in with the user who has the higher permissions.

The menu tree on the left side shows the time until the automatically log out occurs as well as the logged in user. When you move your cursor onto the log-out bar you will get a tool tip which shows how many seconds are remaining until the log-out occurs automatically. Of course you can log out manually with the menu item “log out”.

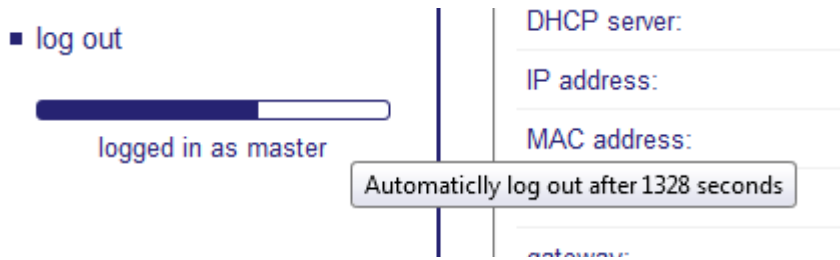

Important:

The automatically log-out occurs to your own safety. It protects the device for unauthorized changes on the configuration if you have forgotten to log out. When you don't view another page from you device for 1 hour the device logs you out automatically.

4.6 Menu item firmware update

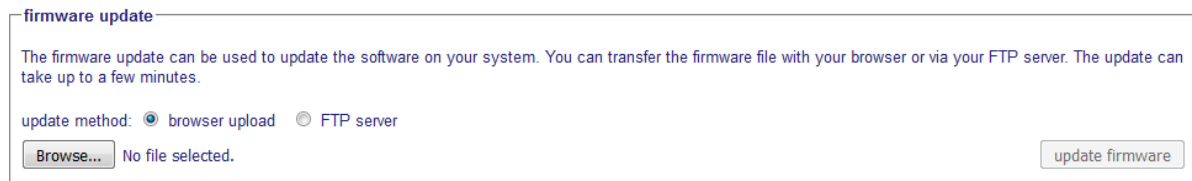

The screenshot shows a web interface for firmware updates. At the top, it says "firmware update". Below that, a paragraph explains that the update can be used to update the software on the system and can be transferred via a browser or an FTP server, taking a few minutes. There are two radio buttons for the update method: "browser upload" (which is selected) and "FTP server". Below the radio buttons, there is a "Browse..." button and the text "No file selected.". On the right side of the interface, there is an "update firmware" button.

On this menu item you can update the firmware of your EtherSens device. You can do the upload via your browser and your PC or via the configured FTP server.

For an upload with the browser and PC you have to click on the button "Browse ...". Now you can choose the firmware file which is stored on your PC. The file name has to be "EtherSensVxxy.hex" (x = version, y = sub version).

For an upload with the FTP server you have to choose the update method "FTP server". Next you can press the button "search on FTP server". Now the search on the server gets executed. Please note that the file gets only searched on the configured directory and not in subdirectories. If a file was found (with the same file scheme as above), the file name will be displayed on the right side of the button.

Neither you have chosen "browser upload" or "FTP server" the next step will be to press the button "update firmware". Therefore the selected file gets uploaded from your PC or from the FTP server to the SD card of your EtherSens device. After a successful upload the file gets checked for errors and perhaps the bootloader gets updated. After that you will be redirected to the reboot page.

After the restart the firmware update occurs. While doing this the red LED of your device will flash cyclically. After the update the device boots normally. The stored firmware file will be deleted on the SD card after a successful firmware update.

4.7 Menu item change password

change password for

own current password:

change password for user

change password: change password

new password:

retype new password:

change password for expert

change password: change password

new password:

retype new password:

change password for master

change password: change password

new password:

retype new password:

On this page you can change the passwords of the users from your device. Therefore you have to enter your own current password first. Now you can select the users from which the password should be changed. The new password from a user must be entered twice to verify the entering. Of course you can change the password of multiple users at the same time.

The basic user can only change his own password. The expert user has the permission to changes the passwords for user and expert. The master can change the passwords from all users (see screenshot).

After clicking on the “save” button the new password will be submitted. Now your device can only be configured with the new password for the changed users!

Important:

We recommend changing the password of your device because the default password is a empty password and thus a access from a third person is easily possible.

4.8 Menu item factory reset

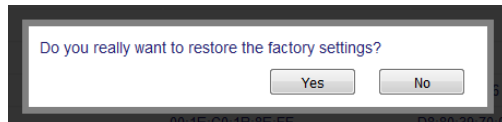

With the menu item “factory reset” you can restore the factory settings of the device. When you click on “Yes” you will get a second prompt which asks you if IP addresses should also be reset. After you have asked this question the factory settings getting restored and you will be redirected to the restart page.

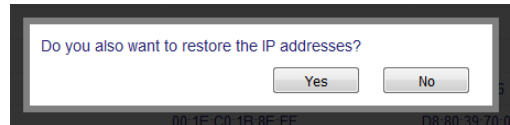

The menu item is only available for the master user. When you can't access your device anymore or when you have forgot your password you can execute a manual reset. Therefore you must push the reset button on the bottom / back side of your device. To restore the factory settings you have to push the reset button while the device is booting (after a restart or after plugging in the power supply). The button (label “FS”) should be pushed with a paperclip and be hold for 3s to 10s.

Please note that the device is only available under the following network properties after a reset (except you haven't restored the network settings):

LAN interface: IP address: 192.168.1.59

WLAN interface: IP address: 192.168.1.58

SSID “EtherSens WiFi”

Connect your PC with this network and pay attention to the correct subnet. If applicable you can enable DHCP on your PC. Thereby your PC will assign the IP settings from the EtherSens.

4.9 Menu item reboot

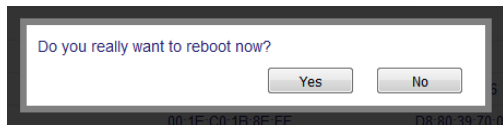

On this menu item you can reboot your device. After clicking on the menu item “reboot” you will see a prompt where you have to confirm the reboot of the device. The reboot can only be executed if you are logged in.

After you have confirmed the reboot you will be redirected to the reboot page which looks like the following:



After a few seconds the reboot signal gets sent to the device and you will see the following message:

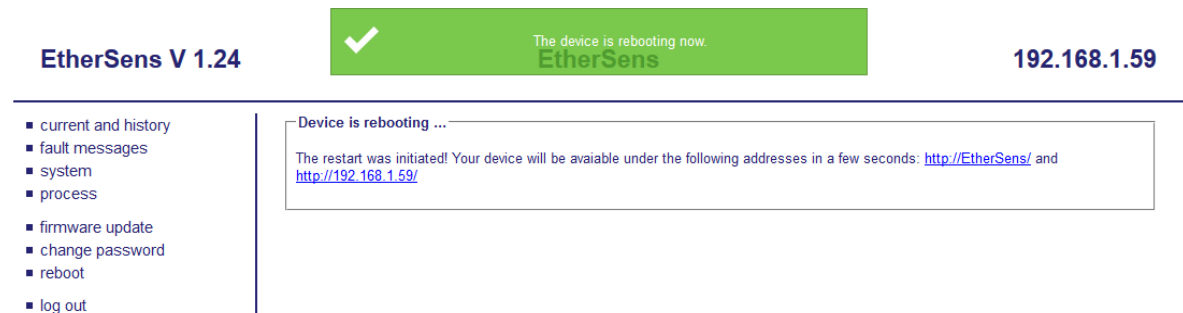

After about 10 seconds the web page will try to reconnect to the device via it's device name (netBIOS name) and it's IP address periodically. If the connection could be established you will be redirected to the start page of the device automatically. Alternatively you can click on one of the addresses on the web page or enter the address in the address line of your browser manually.

4.10 Menu item error log

error log

The error log gives you an overview of the errors which occurred while using the device. Errors who get logged are connection problems and access errors to the FTP server, SMTP server or POP server as well as some other errors. With the protocol you can then determine for example why the FTP backup hasn't worked or why the e-mail couldn't be delivered. For using the error log you need to plug in a valid SD card into your device.

disable log

enable extended log

delete log file

date and time	error group	error content
20.11.2020 12:07:36	network	NTP connection error
20.11.2020 10:52:57	network	NTP connection error
20.11.2020 10:48:27	network	connection lost or timeout (SMTP)
20.11.2020 10:47:46	network	NTP connection error

On the page “error log” you can view the last 50 logged errors. The errors are saved on the SD card in the file logfile.txt. Viewing the log is only available for the user master. To stop the logging the button “disable log” can be used. By default the logging of errors is enabled. By pressing the button “delete log file” the file logfile.txt and thus all log entries in the log are getting deleted.

If the normal error logging is enabled you can enable an additionally “extended log”. When this option gets activated some further errors as well as state changes are getting logged. This option is disabled by default and should only be enabled in error cases in collusion with the technical support.

4.11 Menu item system status

The menu item “system status” is only visible and accessible for the master user. The page shows different status information about the device or rather the software from the EtherSens. If you have problems with your EtherSens the content of the page may be helpful for the technical support.

4.12 Menu item instruments

The instrument pages are special overview pages which contains some selected process values. The pages are optimized for viewing on smart phones and tablets but can also be viewed on a PC.

To put the process values to the foreground the pages does not contain a head line, foot line and menu tree. A menu tree can be viewed or hided by clicking / tipping on the page or using the keys “enter” (view menu) and “escape” (hide menu).

The menu item “instruments” is just a item with sub items and does not include a page by itself. Depending on your device you have different instrument pages. The name of the pages is a contraction from the page name and the device name (indicated in brackets behind the page name).

The following pages are available for the different devices:



- Energy devices and **MONI**
 - V - A - Hz: Displays the voltages, currents and the line frequency
 - power: Displays the active, reactive and apparent power as well as the phase angle / power factor
 - energy total: Displays the active, reactive and apparent energy
 - energy fundamental: Display the active and reactive energy of the fundamental vibration as well as the THD values (Total Harmonic Distortion) for the active and reactive energy

4.12.1 Menu item V - A - Hz

topology: three phase wye	L1	L2	L3	N
U	229.78 V	230.81 V	231.71 V	
I	6.24 A	10.00 A	8.51 A	9.35 A
f	50.00 Hz			



U voltages (for L1, L2 and L3)
 I currents (for L1, L2, L3 and N)
 f line frequency

4.12.2 Menu item power

topology: three phase wye	L1	L2	L3	
P	1.23 kW	1.94 kW	1.59 kW	 4.76 kW
Q	0.62 kVAR	0.60 kVAR	-0.65 kVAR	 0.57 kVAR
S	1.42 kVA	2.28 kVA	1.92 kVA	 5.62 kVA
PF	0.89 cos	0.93 cos	0.85 cos	

P active power (for L1, L2 and L3)
 Q reactive power (for L1, L2 and L3)
 S apparent power (for L1, L2 and L3)
 PF phase angle / power factor (for L1, L2 and L3)

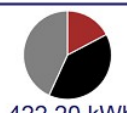
4.12.3 Menu item energy total

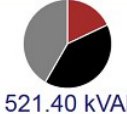

topology: three phase wye	L1	L2	L3	
W_P	73.10 kWh	167.00 kWh	182.10 kWh	 422.20 kWh
W_Q	21.50 kVARh	75.60 kVARh	-79.60 kVARh	 17.50 kVARh
W_S	93.80 kVAh	210.60 kVAh	217.00 kVAh	 521.40 kVAh

W_P total active energy (for L1, L2 and L3)

W_Q total reactive energy (for L1, L2 and L3)

W_S total apparent energy (for L1, L2 and L3)

4.12.4 Menu item energy fundamental

topology: three phase wye	L1	L2	L3	
W_P	43.90 kWh	100.00 kWh	109.90 kWh	 253.80 kWh
W_Q	12.90 kVARh	45.70 kVARh	-26.20 kVARh	 32.40 kVARh
THD_P	66.51 %	67.10 %	65.70 %	
THD_Q	66.67 %	65.43 %	203.82 %	

W_P fundamental active energy (for L1, L2 and L3)

W_Q fundamental reactive energy (for L1, L2 and L3)

THD_P THD value for the active energy (for L1, L2 and L3)

THD_Q THD value for the reactive energy (for L1, L2 and L3)

5 PLC controlled e-mail- and SMS delivery

With the devices of the EtherSens family you have the possibility to pick up ASCII-data via RFC1006 from a PLC (S5- or S7-PLC) and send them as an e-mail or SMS.

Furthermore you can write the content of an e-mail to a PLC via the e-mail reception function.

If you want to send e-mail/SMS directly or without a PLC controller, you can do this by defining limit values within your device. A description for this can be found in the section 4.4.4 Menu item limit values.

S5-PLC:

To communicate with a S5-PLC you need to plug the S5-LAN++ module on the PG interface of the PLC. If the interface is blocked through another device or cable you can use a multiplexer like PG-MUX-II to double the interface.

S7-PLC:

If you have a S7-PLC without a PN interface you can communicate with the MPI or Profibus interface. Therefore you must plug the S7-LAN module on the bus with a free bus address. With the help of the S7-LAN module the SPS can now communicate via RFC1006. If your S7-PLC already has a PN interface you don't need any further hardware.

5.1 Configuration

To globally activate the PLC message sending you have to check the function "PLC message sending" in the menu item "system" → "e-mail" (group "e-mail") and / or the function "SMS PLC message" in the menu item "system" → "USB" (group "LTE module"). If you want to disable the message sending you can remove the selections from the checkboxes.

For using the PLC message sending with e-mail it is necessary to configure the SMTP server (menu item "system" → "e-mail" (group "SMTP server")).

If you want to use the PLC message sending via SMS you have to configure the LTE module (menu item “system” → “USB” (group “USB” and “LTE module”)) The configuration fields were already explained in the chapter “web server”.

To globally activate the PLC message reception you have to check the function “PLC message reception” in the menu item “system” → “e-mail” (group “e-mail”). With this setting you can also disable the reception of all PLC messages.

After you have configured the mail or SMS delivery you have to make changes on the process list. Therefore the first step is to create a RFC1006 device (if not already created). To add a RFC1006 device you have to navigate to “process” → “devices”, fill in the last row and select “RFC1006” as interface. Future you have to enter the IP address of your S5-LAN++ module, S7-LAN module or your S7-PLC and choose the network interface. As last step you have to enter the rack and slot value (*normally: rack 0, slot 2, see also “web server” → “Menu item process” → “Menu item devices” → “Menu item client”*) and finally click on the add icon and after that on the “save” button.

As last step for configuring the PLC controlled message you have to add the PLC message. To add such a message you have to go to “process” → “PLC messages”. The explanation of the configuration fields can be found in the “web server” chapter of this manual.

Important:

The PLC message reception is available for e-mails only.

5.2 Structure of flag-word for packet control

Important:

This flag word is only used when the EtherSens device is a replacement for an ASCII-Tele route. If there isn't a dial process or a control for the data flow the checkbox in the respective entry on the page "process" → "PLC messages" should be disabled.

example: MW10

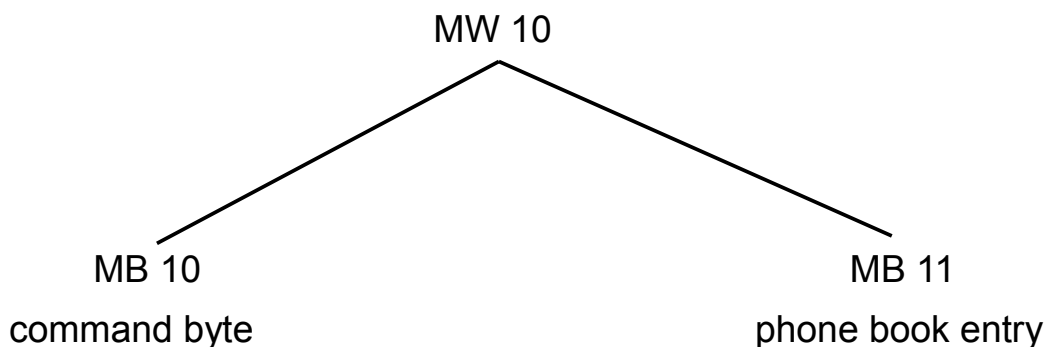

Command overview for the command-byte

01h: *Start dialing process*

After a connect with the remote site, in this register is written back a 10h. When selecting an ASCII-TELE-LINK, you obtain after 20 seconds back a 60h, after the two modems have established the connection or the called ASCII-participant has already been a row that he at the PLC wants to send before these 20 seconds are expired. If the PLC wants to send immediately, it must be selected with 04h.

02h: *Hang up the modem*

This command is only possible if the connected TELE-LINK is the caller (actor) or if no telephone connection exists. The TELE-LINK then disconnects the existing connection. If the command is executed, in the command register is placed a 30h, in case of an error a 50h.

03h: *Hang up the modem necessarily*

This statement is executed immediately and directly in any case. It gives back a 30h in the same register.

04h: *Call ASCII-subscriber*

An ASCII number is called. If thereafter takes place a connect, the PLC sends a 60h for the connection with ASCII participants.

Advantage: After a connect the PLC can immediately deposit the ASCII commands.

The EtherSens device doesn't compare between the commands 01h and 04h and 02h and 03h.

Feedback from EtherSens in the command byte

10h: Modem connection available with TELE-LINK (PLC-TELE or PG-TELE)

20h: The number of the desired participant entry is invalid

30h: Modem connection is not available any more, for example, after hanging up or even if the partner has hanged up

40h: No connect possible (probably occupied)

50h: The hang up command 02h could not be executed

60h: Modem connection available with ASCII-participant

The grayed out states aren't used by the EtherSens device. The states were only pictured in this manual for the completeness and parallelism to the Tele-Prof devices.

5.3 Structure of flag word for order status

example: MW12

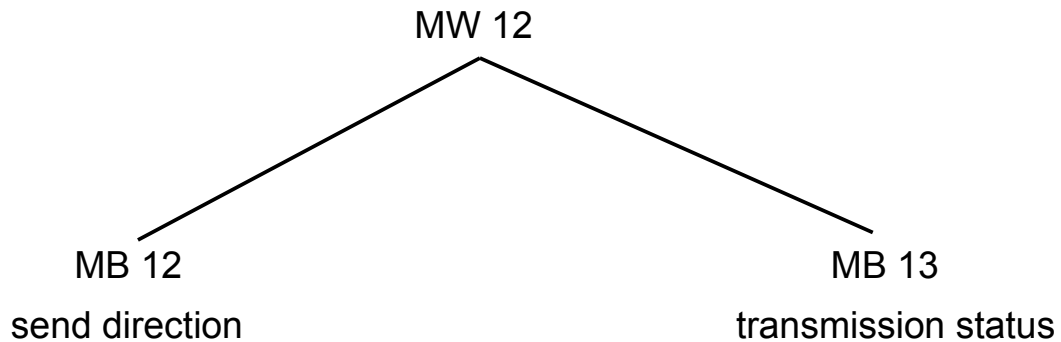

Command overview for the order status word

- 0100h A send order is available in the PLC. All further information (data block, length and start address) are available in the communication DB. The communication DB gets retrieved by the EtherSens after the order was detected.
- 0200h The PLC is ready to receipt data. All further information (data block and start address) are available in the communication DB. The length gets set by the EtherSens in the data block. The content of the communication DB gets retrieved by the EtherSens after the order reached the device and an order in the PLC was detected.

Feedback from EtherSens in the transmission status byte

- 01h: Job completed without errors
- 02h: Job running, but here's to check for TIMEOUT, the job should be done after max. 45 seconds
- 03h: Source block does not exist or is too short
- 04h: Destination block does not exist or is too short
- 05h: General error, job must be repeated
- 06h: Configuration-DB does not exist

07h: parameterization error

08h: The partner device is not an ASCII-participant

The grayed out states aren't used by the EtherSens device. The states were only pictured in this manual for the completeness and parallelism to the Tele-Prof devices.

If the flag word for the packet control is used, the flow control mechanism of the Tele-Prof devices with the commands 020Dh and 030Dh can be used. In this case the commands are written back to the target area.

Important:

If an order was already completed the transmission status has to be reset to 00h. The detection of an order is only possible if the word contains 0100h or 0200h.

5.4 Structure of communication-DB

	Name	Data type	Offset	Start value	Retain	Visible in HMI	Setpoint	Comment
1	▼ Static				<input type="checkbox"/>	<input type="checkbox"/>	<input type="checkbox"/>	
2	■ Source_Type	Word	0.0	'DB'	<input checked="" type="checkbox"/>	<input checked="" type="checkbox"/>	<input type="checkbox"/>	
3	■ Source_Number	Word	2.0	3	<input checked="" type="checkbox"/>	<input checked="" type="checkbox"/>	<input type="checkbox"/>	
4	■ Source_Address	Word	4.0	1	<input checked="" type="checkbox"/>	<input checked="" type="checkbox"/>	<input type="checkbox"/>	
5	■ Source_Length	Word	6.0	11	<input checked="" type="checkbox"/>	<input checked="" type="checkbox"/>	<input type="checkbox"/>	
6	■ Target_Type	Word	8.0	'DB'	<input checked="" type="checkbox"/>	<input checked="" type="checkbox"/>	<input type="checkbox"/>	
7	■ Target_Number	Word	10.0	3	<input checked="" type="checkbox"/>	<input checked="" type="checkbox"/>	<input type="checkbox"/>	
8	■ Target_Address	Word	12.0	128	<input checked="" type="checkbox"/>	<input checked="" type="checkbox"/>	<input type="checkbox"/>	
9	■ Target_Length	Word	14.0	1	<input checked="" type="checkbox"/>	<input checked="" type="checkbox"/>	<input type="checkbox"/>	

Source_Type: Data type for the source (always „DB“).

Source_Number: DB number for the source data.

Source_Address: Start address for the source data.

Source_Length: Length for the source data.

Target_Type: Data type for the target (always „DB“).

Target_Number: DB number for the target data.

Target_Address: Start address for the target data.

Target_Length: Length for the target data.

The evaluation of the offset and length fields depends on the setting “addressing type” of the PLC message, which can be changed on the website in the menu “process” → “PLC messages”.

If you have selected the addressing type “S5 (word)” the data will be evaluated as follows:

source: DB3.DBB2 length 22 bytes (11 words)

destination: DB3.DBB256 length 2 bytes (1 word)

If you have selected the addressing type “S7 (byte)” the data gets interpreted as follows:

source: DB3.DBB1 length 11 bytes

destination: DB3.DBB128 length 1 byte

5.5 Structure of receiver DB

	Name	Data type	Offset	Start value	Retain	Visible in HMI	Setpoint	Comment
1	Static				<input type="checkbox"/>	<input type="checkbox"/>	<input type="checkbox"/>	
2	Receiver	String	0.0	'test@example.com'	<input checked="" type="checkbox"/>	<input checked="" type="checkbox"/>	<input type="checkbox"/>	

Receiver: E-mail address or telephone number of the receiver.

Important:

The receiver have to be a S7 string, because first the byte 1 of the DB is read to determine the length. Only then the real data is read. Furthermore the receiver may not exceed 100 characters.

5.6 Expiration of PLC controlled delivery

First the PLC has to write the communication and possibly the receiver DB. In this DBs the information about the data which should be sent from the EtherSens device and the receiver of the message is placed. Next the PLC writes the order status 0100h in the order status word.

Important:

It is necessary that the transmission status gets overwritten with 00h from the PLC. Otherwise the e-mail or SMS gets not sent!

The EtherSens which polls the flag word for the order status detects the order and assembles the e-mail or SMS with the data from the data-DB. But first the receiver (e-mail address or telephone number) from the receiver DB will be read, if the setting for the receiver DB is enabled. When the order is finished and the e-mail or SMS is sent successfully the EtherSens device writes the 01h into the transmission status.

Thus the flag word for the order status has now the value 0101h and the device is ready for a new order.

Important:

If the setting for the receiver DB is disabled the message gets always sent as e-mail. The receiver of this e-mail is the e-mail address which is configured in the SMTP settings. If you want to send SMS you have to use the receiver DB.

The device has the possibility to detect, if the receiver from the DB is an e-mail address or telephone number. If you have specified a telephone number although no LTE module is connected you will get back the state 05h. If you have disabled the SMS PLC message sending but specified a telephone number in the DB the state 07h will be given back. This will also affect the other way around.

For sending a further mail or SMS the PLC must rewrite the DBs and set the the flag word for the order-status back to the value 0100h.

When the flag word for the packet control is used the EtherSens device will check if a connection to the PLC was established. Therefore the command byte have to has the value 01h or 04h. Afterwards the order status gets polled as described above. This operation gets lopped until the connection get closed with the help of the commands 02h or 03h as value in the command byte. All orders within a connection are than get packed in one e-mail.

Important:

When sending an SMS the content cannot be longer than 160 Bytes and have to be transferred in one step.

5.7 Expiration of PLC controlled reception

The EtherSens device checks within the specified interval for e-mails in the configured mailbox. If an e-mail gets found which belongs to a enabled PLC message of this device, the e-mail gets deleted after the full reception.

Important:

It is necessary that the transmission status gets overwritten with 00h from the PLC. Otherwise the receipted e-mail gets not written to the PLC!

Until the flag word for the status gets polled for the next time and an e-mail was receipted, the device checks if the word is set to 0200h. The setting of the flag word and the target area in the communication DB have to be done by the PLC in parallelism to the reception of the mail. If no order status for reception is set, the e-mail gets hold in the device, until the PLC is ready for reception. Otherwise the EtherSens reads in the communication DB and sets the length of the target data. Now the EtherSens starts with transmitting the e-mail content to the specified target area. After the transmission to the PLC, the transmission status gets set to 01h.

Thus the flag word for the order status has now the value 0201h and the device is ready for a new order.

Important:

The e-mails which were receipted by the EtherSens are getting stored in the device until the content is written to the PLC or the device gets rebooted.

6 E-mail reception

The devices from the EtherSens family can monitor the mails of a mailbox in cyclical distance and use the mails to control the device. The configuration for this application as well as the expiration of the reception is described in this chapter.

6.1 Configuration

If you want to use the e-mail reception you need an e-mail account which can be accessed by the POP protocol. The access data have to be configured on the menu item “system” → “e-mail” within the group “POP server”. Furthermore you have to enable the option “e-mail reception” and set up the “e-mail reception interval” within the group “e-mail” on the same page. An detailed description of this settings can be found in the chapter “Web server”.

6.2 Expiration of the reception and assignment of e-mails

If the e-mail reception is enabled a connection to the POP server is established and the statistics of the mailbox gets requested in the specified interval. After that the device begins to retrieve the e-mails (only if they are smaller than 8 kilo bytes in total) from the mailbox one by one.

When a mail was retrieved the subject of it gets checked. This is needed because the subject identifies the e-mail and is used to assign the mail. A valid subject for the EtherSens device have to contain the sequence “To:” followed by the device name, a blank space and a @ sign on any position. After the @ sign another sequence which indicates the usage purpose follows. For PLC messages the sequence consists of “MSG” and the index of the PLC message (this can be found on the menu item “process” on the web server). Other usage purposes as the PLC messages are currently not existing but planed.

A simple subject (without further characters) which indicates a message for the device “EtherSens” and it's PLC message with the index 0, looks like the follows:

#To:EtherSens @MSG0

Here is another example subject which indicates a mail for the PLC message 1 for the device “DETECTOR1”:

message machine 43 #To:DETECTOR1 @MSG1

If the retrieved e-mail is directed to the device, the mail gets stored within the device until it's processed and gets deleted on the server. After that and if possible further e-mails are getting retrieved and checked.

Important:

E-mails which aren't processed, but retrieved, are getting hold within the device until a reboot.

7 SMS sending and receiving of process values

If your EtherSens device has a LTE modem you have the ability to send and receive process values. Therefore the SMS have to match a special format.

7.1 Configuration

For using the SMS sending and receiving it's necessary that you have a LTE modem (available as extension card). Furthermore you have to configure the modem via the web server on the page "system" → "USB". The description of the configuration fields are described in the chapter "Web server" of this manual.

7.2 SMS sending

If you want to send a SMS with process values from your EtherSens device you have to create a limit value. This can be done on the web server via the menu item "process" → "limit values". As action you have to choose "SMS".

After that you need to create a own short message (column action value). The content of the short message represents the process values which should be sent. Therefore the @ character and the name of the process value must be given.

Example:

@Active Power L1

In some cases you want to send more than one process value. This can be done by following the above template. Please do not use any other content in such a SMS.

Example:

@Active Power L1@Active Power L2@Active Power L3

If you want to send all process values just type in a single @ character.

After the limit value is reached, the EtherSens searches in the short message for @ characters. If a process value with the noted name exists the value gets inserted.

Example:

```
@Active Power L1=-0.12@Active Power L2=0.73@Active Power L3=2.81
```

The values are transmitted in the configured format without the unit. If the content is too big for one SMS a second SMS gets sent.

If you want to send the SMS cyclical you have to create an internal process value which changes its value between 0 and 1 within the half of the cycle time. As limit value you choose the created internal value and check it if it's 1.

Important:

Please note that sending SMS can cause costs.

7.3 SMS receiving

The EtherSens checks cyclical if incoming SMS are available. If this is true the SMS is getting retrieved and processed.

If the SMS contains an @ character followed by the process value name, a = character and a value, the device checks if a process value with this name exists. If the process value is found the value of the process value gets set.

Example:

```
@Digital-IO 1=1@Digital-IO 2=0@Digital-IO 3=0@Digital-IO 4=1
```

If the EtherSens receives a SMS with the content of the message above the device searches for the process values with the name "Digital-IO 1", "Digital-IO 2", "Digital-IO 3" and "Digital-IO 4" and set the values 1, 0, 0 and 1 to the process values.

Important:

After the SMS is processed the message gets deleted.

The sending and receiving of process value via SMS can be used for coupling two EtherSens devices, which are connected via the mobile network. Therefore both devices are needing process values with the same name. This of course only applies to the process values which should be transferred.

Certainly it is also possible to send process values from a EtherSens device to a mobile phone or sending process values with write values from a mobile phone to a EtherSens device.

8 Coupling with WinCC

The devices of the EtherSens family have an integrated RFC1006 server. Thereby it's possible to get and set the process values via a RFC1006 client (e. g. WinCC or a other EtherSens device).

All 150 process values from a EtherSens are filled in the data block 1 in the range of DB1.DBB0 to DB1.DBB399. Every process value needs 4 bytes that means the process value with the index 2 (index is null based) can be retrieved with DB1.DBD8. The EtherSens devices are supporting retrieving bytes, words, double words and bits. Also it's possible to read over a limit of a process value (e. g. for getting 2 process value). Getting flags, inputs, outputs, timers or counters is not possible. For faulty requests the EtherSens behaves like described in the protocol.

After you have started WinCC you have to add a new connection. At the selection list "Communication driver" you should choose "SIMATIC S7 300/400". Future you have to enter the IP address of the EtherSens at the input filed "PLC" → "Address". The settings "Expansion slot" and "Rack" doesn't have any affect.

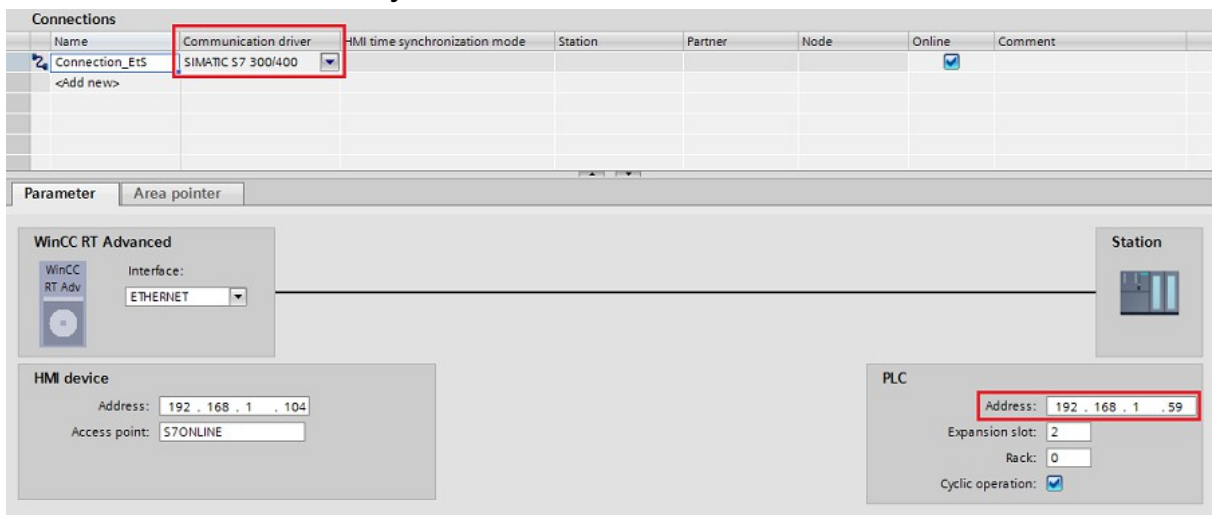

Next you have to configure your variables / tags which should be read or written.

A running visualization in WinCC can look like follows:

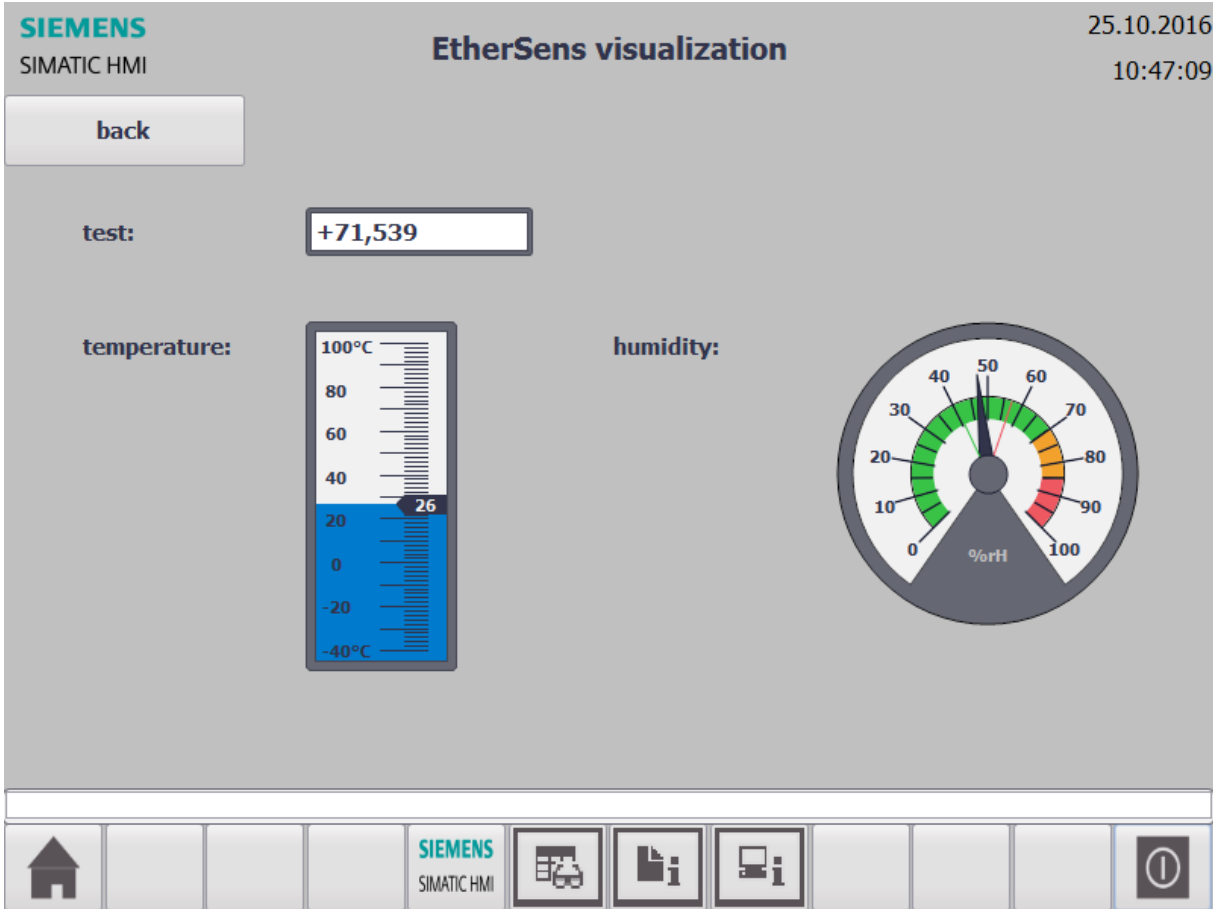

If you want to see, which IP addresses are currently connected to the EtherSens device through RFC1006 you can look at the table “RFC1006 server” on the page “process” (see image).

RFC1006 server

index	network interface	remote ip address	remote Port	state
0	LAN	192.168.1.104	49216	receive DT

9 Process server

The process server of the EtherSens allows you to read or write process values from or to the device. All available process servers are described in this chapter.

The RFC1006 server also belongs to the process server. But because the RFC1006 server is mainly used for the WinCC coupling, this process server doesn't get described in more detail here. More information about the RFC1006 server, e. g. the addressing of process values, can be found in the chapter "Coupling with WinCC".

9.1 TCP process server

The TCP process server allows you an easy access and protocol. The TCP process servers uses a TCP connection on port 65535 (or the port which is configured on the server device configuration page). The requests to the EtherSens device and the responses from the EtherSens have the following structure:

byte 0-1	byte 2	byte 3-6
process value index	identification	data (optional)

The process value index consists of 2 bytes of which the first byte must be 0x00. The "real" index of the process value (0 to 150) is specified in the second byte. If you don't know the index of your process values you can look at the process status page on the web server.

Byte 2 is used as identification character. The following characters are available:

character	description	direction
? (0x3F)	request for reading	client → server
! (0x21)	request for writing	client → server
= (0x3D)	reading successful, data follows	server → client
+ (0x2B)	writing successful	server → client
- (0x2D)	processing failed	server → client

The data (byte 3-6) may only be sent if it's a write request or a response to read request (only if it was successful).

Important:

If you read or write process values you have to respect the byte order. In the TCP process server protocol the least significant byte of the value (data field) must be transmitted first and the most significant byte last.

examples:

- Reading the process value with the index 0:
 - 00 00 3F request
 - 00 00 3D 01 02 03 04 response (value = 0x04030201)
- Writing the process value with the index 5:
 - 00 05 21 01 02 03 04 request (value = 0x04030201)
 - 00 05 2B response
- Reading the process value with the index 80, assuming this values doesn't exists:
 - 00 50 3F request
 - 00 50 2D response

If you want, you can put multiple requests in a single packet. In the following example the process values with the index 1 and 2 are requested for reading:

00 01 3F 00 02 3F

In such a case the EtherSens normally also put the responses in one packet:

00 01 3D 01 02 03 04 00 02 3D 05 06 07 08

➔ process value 1: value = 0x04030201

➔ process value 2: value = 0x08070605

The communication via this protocol can be implemented on various programming languages easily. A simple example for reading and writing

a process value with the socket extension of PHP can be found in the appendix.

9.2 SNMP process server

The communication via the SNMP process server of the EtherSens is running with the standardized SNMP protocol (TCP port 161). With the help of this protocol you can read the system runtime and the values of the process values. The process values can be written also. For addressing the so-called Object Identifiers (OID) are used. The OIDs are described below in more detail.

The runtime of the EtherSens device can be read via the standardized OID 1.3.6.1.2.1.1.3.0. The returned value is a time-tick-value which represents the runtime of the system in hundredths of a second.

The products of the EtherSens family have an own branch in the MIB structure of the company Process-Informatik. The “company id” (Enterprise Number) of Process-Informatik is 49399. The devices of the EtherSens family are placed within the sub node 1. The full address / OID of the EtherSens devices is 1.3.6.1.4.1.49399.1.

The structure of the OID is composed as follows:

```
1 .3 .6 .1 .4 .1 .49399.1  
iso.org.dod.internet.private.enterprise.pi .ethersens
```

The ethersens-OID currently contains only one sub node with the number 1. This node is used for accessing the process values. After addressing the process values node, a single process value must be addressed. Therefore the index of the value + 1 is used. The index of the process values can be looked up at the “process” page. At the end of the OID .0 must be attached.

Examples (factory default of EtherSens Energy):

Index	Name	OID
0	Voltage L1 (rms)	1.3.6.1.4.1.49399.1.1.1.0
1	Voltage L2 (rms)	1.3.6.1.4.1.49399.1.1.2.0
2	Voltage L3 (rms)	1.3.6.1.4.1.49399.1.1.3.0
3	Current L1 (rms)	1.3.6.1.4.1.49399.1.1.4.0

Important:

Process values with the formats float and scientific are also transmitted decimal. Therefore the value is multiplied with 1000. If you want to show the value as floating point number the number has to be divided through 1000.

If you want, you can export a MIB file which contains all process values of your device. This export can be started on the menu item “system” → “general”. The description for the export you will find in the “web server” chapter.

10 Device couplings

In this chapter various couplings between the EtherSens device and another device are described. The configuration of this couplings can be done on the web page of the device on the menu item “process” → “devices” → “couplings”.

Simple couplings where only a client device and process values have to be configured aren't explained here again. The explanation can be found on the chapter “Web server” of this manual.

10.1 PLC socket coupling

The PLC socket coupling can be used for a simple data transfer between a PLC and a simple TCP socket. Therefore data which is received via the TCP socket is written to the target area of the PLC. After that the data from the source area of the PLC get's read and sent back via the TCP socket.

10.1.1 configuration

First you have to configure a RFC1006 connection for the PLC, which should be used for the coupling, on the menu item “process” → “devices” → “client”, if not already done. As the next and final step you have to configure the coupling on the menu item “process” → “devices” → “couplings”.

10.1.2 procedure

If you have done the configuration and enabled the coupling, the EtherSens device waits for an connection on the configured TCP port. If a connection is established data have to be sent via the TCP connection. The length of the expected data is configured via the parameter “length PLC target”.

If the data could be received, the EtherSens starts to check if the target area in the PLC is empty (filled with 0x00). If this true, the data which was received via the TCP connection get's written in the target area of

the PLC. Otherwise the area get's checked after the specified "polling time" again.

On the next step the EtherSens starts to check the source area of the PLC. If data is available in the area and not empty (filled with 0x00), the source area get's cleared (filled with 0x00) by the EtherSens and the originally data of the area get's sent back via the TCP connection. Otherwise the checking of the source area repeats in the specified interval until data is available.

Afterwards the EtherSens waits until the TCP connection is closed or closes the connection by itself (depending on the setting). Now the next connection can be established.

11 L1 bus communication

With the EtherSens you are able to access a L1 bus. Therefore you can use the bus monitor on the web page or the network protocol RFC1006.

11.1 Bus monitor

sender											receiver																			
slave 1..30,31	<input type="text" value="1"/>										[dec]	slave	<input type="text" value="0"/>										[dec]							
numplus	<input type="text" value="0x00"/>										[hex]																			
ZBS	<input type="text" value="00000000"/>										[bin]	ZBS	<input type="text" value="00000000"/>										[bin]							
length 0..64	<input type="text" value="0"/>										[dec]	length	<input type="text" value="0"/>										[dec]							
BCC1	<input type="text" value="0x00"/>										[hex]	BCC1	<input type="text" value="0x00"/>										[hex]							
source	<input type="text" value="0"/>										[dec]	source	<input type="text" value="0"/>										[dec]							
BCC2	<input type="text" value="0x00"/>										[hex]	BCC2	<input type="text" value="0x00"/>										[hex]							
receipt	<input type="text" value="0x00"/>										[hex]	receipt	<input type="text" value="0x00"/>										[hex]							
AG target state	<input 10"="" type="text" value="---</input></td> <td></td> <td>AG actual state</td> <td colspan="/> <input text"="" type="text" value="----</input></td> <td></td> </tr> <tr> <td>data</td> <td>+0</td><td>+1</td><td>+2</td><td>+3</td><td>+4</td><td>+5</td><td>+6</td><td>+7</td><td>+8</td><td>+9</td> <td>data</td> <td>+0</td><td>+1</td><td>+2</td><td>+3</td><td>+4</td><td>+5</td><td>+6</td><td>+7</td><td>+8</td><td>+9</td> </tr> <tr> <td>+0</td> <td><input type="/>										<input type="text"/>	<input type="text"/>	<input type="text"/>	<input type="text"/>	<input type="text"/>	<input type="text"/>	<input type="text"/>	<input type="text"/>	<input type="text"/>	+0	<input type="text" value="0x00"/>	<input type="text" value="0x00"/>	<input type="text" value="0x00"/>	<input type="text" value="0x00"/>	<input type="text" value="0x00"/>	<input type="text" value="0x00"/>	<input type="text" value="0x00"/>	<input type="text" value="0x00"/>	<input type="text" value="0x00"/>	<input type="text" value="0x00"/>
+10	<input type="text"/>	<input type="text"/>	<input type="text"/>	<input type="text"/>	<input type="text"/>	<input type="text"/>	<input type="text"/>	<input type="text"/>	<input type="text"/>	<input type="text"/>	+10	<input type="text" value="0x00"/>	<input type="text" value="0x00"/>	<input type="text" value="0x00"/>	<input type="text" value="0x00"/>	<input type="text" value="0x00"/>	<input type="text" value="0x00"/>	<input type="text" value="0x00"/>	<input type="text" value="0x00"/>	<input type="text" value="0x00"/>	<input type="text" value="0x00"/>									
+20	<input type="text"/>	<input type="text"/>	<input type="text"/>	<input type="text"/>	<input type="text"/>	<input type="text"/>	<input type="text"/>	<input type="text"/>	<input type="text"/>	<input type="text"/>	+20	<input type="text" value="0x00"/>	<input type="text" value="0x00"/>	<input type="text" value="0x00"/>	<input type="text" value="0x00"/>	<input type="text" value="0x00"/>	<input type="text" value="0x00"/>	<input type="text" value="0x00"/>	<input type="text" value="0x00"/>	<input type="text" value="0x00"/>	<input type="text" value="0x00"/>									
+30	<input type="text"/>	<input type="text"/>	<input type="text"/>	<input type="text"/>	<input type="text"/>	<input type="text"/>	<input type="text"/>	<input type="text"/>	<input type="text"/>	<input type="text"/>	+30	<input type="text" value="0x00"/>	<input type="text" value="0x00"/>	<input type="text" value="0x00"/>	<input type="text" value="0x00"/>	<input type="text" value="0x00"/>	<input type="text" value="0x00"/>	<input type="text" value="0x00"/>	<input type="text" value="0x00"/>	<input type="text" value="0x00"/>	<input type="text" value="0x00"/>									
+40	<input type="text"/>	<input type="text"/>	<input type="text"/>	<input type="text"/>	<input type="text"/>	<input type="text"/>	<input type="text"/>	<input type="text"/>	<input type="text"/>	<input type="text"/>	+40	<input type="text" value="0x00"/>	<input type="text" value="0x00"/>	<input type="text" value="0x00"/>	<input type="text" value="0x00"/>	<input type="text" value="0x00"/>	<input type="text" value="0x00"/>	<input type="text" value="0x00"/>	<input type="text" value="0x00"/>	<input type="text" value="0x00"/>	<input type="text" value="0x00"/>									
+50	<input type="text"/>	<input type="text"/>	<input type="text"/>	<input type="text"/>	<input type="text"/>	<input type="text"/>	<input type="text"/>	<input type="text"/>	<input type="text"/>	<input type="text"/>	+50	<input type="text" value="0x00"/>	<input type="text" value="0x00"/>	<input type="text" value="0x00"/>	<input type="text" value="0x00"/>	<input type="text" value="0x00"/>	<input type="text" value="0x00"/>	<input type="text" value="0x00"/>	<input type="text" value="0x00"/>	<input type="text" value="0x00"/>	<input type="text" value="0x00"/>									
+60	<input type="text"/>	<input type="text"/>	<input type="text"/>	<input type="text"/>							[hex]	+60	<input type="text" value="0x00"/>	<input type="text" value="0x00"/>	<input type="text" value="0x00"/>	<input type="text" value="0x00"/>					[hex]									

state: wait for transfer / last state: transmitting successfully completed

transfer: AG target state: receiver send:

On the menu item “system status” in the register “network applications” you click on a button to open the L1 bus monitor. After clicking on the button a second window (pop up) will appear. This page is divided to sender and receiver. Further the page contains a status line and buttons on the bottom.

On the sender side you can fill in some fields which are needed for the transfer. Therefore you first have to fill in the fields “slave” as target address and “length” as data length. Through the entering of the length the input fields for the data are getting enabled automatically. In this input fields the data can be entered (every input field represents one byte).

If you want to change the state of the AG you can use the button “AG target state”. The text on the button shows the chosen state (---, RUN or STOP).

With the button “receiver send” you can allow or forbid the sending of data from the receiver.

To start a (single / manual) transfer you can click on the button “transfer”. After clicking on the button the entered values and the settings (“AG target state” and “receiver send”) gets sent to the EtherSens device which redirects the data to the L1 bus.

11.2 RFC1006 protocol

For accessing the L1 bus you can also use the network protocol RFC1006 (TCP port 102). At the “Connection Request” (CR) packet the source and destination TSAP must be equal to the characters “L1” (0x4C31). After sending the CR packet the EtherSens confirms with a “Connection Confirm” (CC) packet.

After the connection establishment “Data Telegram” (DT) packets can be sent. The data packets which are sent to the EtherSens must have the following structure:

0	1	2	3	4..*
source no.	target no.	AG state	length (0 to 64)	data (optional)

The replies from the EtherSens has the same structure as shown above. If a error occurs, the structure of the packet is as follows:

0	1	2
0xFF	0xFF	error code

The following list shows all available AG states:

value	description
0x20	slave can only receive data
0x40	AG state RUN
0x80	AG state STOP

The AG states can be bit-wise OR-connected.

e. g. 0x20 | 0x40 = 0x60

The following list shows all available error codes:

code	description
1	invalid length < 0 or > 64
2	invalid slave no < 1 or > 31
3	error at break
4	error while sending numplus
5	timeout while receiving slave no
6	wrong slave no received from AG
7	error while transmitting ZBS
8	error while transmitting length
9	error while transmitting BCC1
10	error while transmitting source
11	error while transmitting data
12	error while transmitting BCC2
13	timeout while receiving ZBE
14	timeout while receiving length
15	faulty length received
16	timeout while receiving BCC1
17	faulty BCC1 received

18	timeout while receiving from target
19	target is not master
20	timeout while receiving data
21	timeout while receiving BCC2
22	faulty BCC2 received
23	error while sending ZBS at receipt
24	error while sending receipt
25	error while sending BCC1 at receipt
26	interface error

12 Modbus communication

The EtherSens devices are supporting the Modbus protocol over the serial line (RTU and ASCII). Depending on the configuration the device can work as master or as slave.

12.1 Modbus master

While operating as Modbus master the EtherSens device is sending requests and waits for a reply. If you want to send such a request you can use the bus monitor on the web page or the RFC1006 protocol. Furthermore the EtherSens can generate own requests for reading or writing process values from / to Modbus slaves.

12.1.1 Bus monitor

sender														receiver																	
slave 0..247	<input type="text" value="1"/>													[dec]	slave	<input type="text" value="0"/>													[dec]		
function code 1..127	<input type="text" value="1"/>													[dec]	function code	<input type="text" value="0"/>													[dec]		
length 0..252	<input type="text" value="0"/>													[dec]	length	<input type="text" value="0"/>													[dec]		
checksum	<input type="text" value="0x0000"/>													[hex]	checksum	<input type="text" value="0x0000"/>													[hex]		
data +0	+1	+2	+3	+4	+5	+6	+7	+8	+9	+10	+11	+12	+13	+14	+15	data +0	+1	+2	+3	+4	+5	+6	+7	+8	+9	+10	+11	+12	+13	+14	+15
+0	<input type="text"/>	<input type="text"/>	<input type="text"/>	<input type="text"/>	<input type="text"/>	<input type="text"/>	<input type="text"/>	<input type="text"/>	<input type="text"/>	<input type="text"/>	<input type="text"/>	<input type="text"/>	<input type="text"/>	<input type="text"/>	<input type="text"/>	+0	0x00	0x00	0x00	0x00	0x00	0x00	0x00	0x00	0x00	0x00	0x00	0x00	0x00	0x00	0x00
+16	<input type="text"/>	<input type="text"/>	<input type="text"/>	<input type="text"/>	<input type="text"/>	<input type="text"/>	<input type="text"/>	<input type="text"/>	<input type="text"/>	<input type="text"/>	<input type="text"/>	<input type="text"/>	<input type="text"/>	<input type="text"/>	<input type="text"/>	+16	0x00	0x00	0x00	0x00	0x00	0x00	0x00	0x00	0x00	0x00	0x00	0x00	0x00	0x00	0x00
+32	<input type="text"/>	<input type="text"/>	<input type="text"/>	<input type="text"/>	<input type="text"/>	<input type="text"/>	<input type="text"/>	<input type="text"/>	<input type="text"/>	<input type="text"/>	<input type="text"/>	<input type="text"/>	<input type="text"/>	<input type="text"/>	<input type="text"/>	+32	0x00	0x00	0x00	0x00	0x00	0x00	0x00	0x00	0x00	0x00	0x00	0x00	0x00	0x00	0x00
+48	<input type="text"/>	<input type="text"/>	<input type="text"/>	<input type="text"/>	<input type="text"/>	<input type="text"/>	<input type="text"/>	<input type="text"/>	<input type="text"/>	<input type="text"/>	<input type="text"/>	<input type="text"/>	<input type="text"/>	<input type="text"/>	<input type="text"/>	+48	0x00	0x00	0x00	0x00	0x00	0x00	0x00	0x00	0x00	0x00	0x00	0x00	0x00	0x00	0x00
+64	<input type="text"/>	<input type="text"/>	<input type="text"/>	<input type="text"/>	<input type="text"/>	<input type="text"/>	<input type="text"/>	<input type="text"/>	<input type="text"/>	<input type="text"/>	<input type="text"/>	<input type="text"/>	<input type="text"/>	<input type="text"/>	<input type="text"/>	+64	0x00	0x00	0x00	0x00	0x00	0x00	0x00	0x00	0x00	0x00	0x00	0x00	0x00	0x00	0x00
+80	<input type="text"/>	<input type="text"/>	<input type="text"/>	<input type="text"/>	<input type="text"/>	<input type="text"/>	<input type="text"/>	<input type="text"/>	<input type="text"/>	<input type="text"/>	<input type="text"/>	<input type="text"/>	<input type="text"/>	<input type="text"/>	<input type="text"/>	+80	0x00	0x00	0x00	0x00	0x00	0x00	0x00	0x00	0x00	0x00	0x00	0x00	0x00	0x00	0x00
+96	<input type="text"/>	<input type="text"/>	<input type="text"/>	<input type="text"/>	<input type="text"/>	<input type="text"/>	<input type="text"/>	<input type="text"/>	<input type="text"/>	<input type="text"/>	<input type="text"/>	<input type="text"/>	<input type="text"/>	<input type="text"/>	<input type="text"/>	+96	0x00	0x00	0x00	0x00	0x00	0x00	0x00	0x00	0x00	0x00	0x00	0x00	0x00	0x00	0x00
+112	<input type="text"/>	<input type="text"/>	<input type="text"/>	<input type="text"/>	<input type="text"/>	<input type="text"/>	<input type="text"/>	<input type="text"/>	<input type="text"/>	<input type="text"/>	<input type="text"/>	<input type="text"/>	<input type="text"/>	<input type="text"/>	<input type="text"/>	+112	0x00	0x00	0x00	0x00	0x00	0x00	0x00	0x00	0x00	0x00	0x00	0x00	0x00	0x00	0x00
+128	<input type="text"/>	<input type="text"/>	<input type="text"/>	<input type="text"/>	<input type="text"/>	<input type="text"/>	<input type="text"/>	<input type="text"/>	<input type="text"/>	<input type="text"/>	<input type="text"/>	<input type="text"/>	<input type="text"/>	<input type="text"/>	<input type="text"/>	+128	0x00	0x00	0x00	0x00	0x00	0x00	0x00	0x00	0x00	0x00	0x00	0x00	0x00	0x00	0x00
+144	<input type="text"/>	<input type="text"/>	<input type="text"/>	<input type="text"/>	<input type="text"/>	<input type="text"/>	<input type="text"/>	<input type="text"/>	<input type="text"/>	<input type="text"/>	<input type="text"/>	<input type="text"/>	<input type="text"/>	<input type="text"/>	<input type="text"/>	+144	0x00	0x00	0x00	0x00	0x00	0x00	0x00	0x00	0x00	0x00	0x00	0x00	0x00	0x00	0x00
+160	<input type="text"/>	<input type="text"/>	<input type="text"/>	<input type="text"/>	<input type="text"/>	<input type="text"/>	<input type="text"/>	<input type="text"/>	<input type="text"/>	<input type="text"/>	<input type="text"/>	<input type="text"/>	<input type="text"/>	<input type="text"/>	<input type="text"/>	+160	0x00	0x00	0x00	0x00	0x00	0x00	0x00	0x00	0x00	0x00	0x00	0x00	0x00	0x00	0x00
+176	<input type="text"/>	<input type="text"/>	<input type="text"/>	<input type="text"/>	<input type="text"/>	<input type="text"/>	<input type="text"/>	<input type="text"/>	<input type="text"/>	<input type="text"/>	<input type="text"/>	<input type="text"/>	<input type="text"/>	<input type="text"/>	<input type="text"/>	+176	0x00	0x00	0x00	0x00	0x00	0x00	0x00	0x00	0x00	0x00	0x00	0x00	0x00	0x00	0x00
+192	<input type="text"/>	<input type="text"/>	<input type="text"/>	<input type="text"/>	<input type="text"/>	<input type="text"/>	<input type="text"/>	<input type="text"/>	<input type="text"/>	<input type="text"/>	<input type="text"/>	<input type="text"/>	<input type="text"/>	<input type="text"/>	<input type="text"/>	+192	0x00	0x00	0x00	0x00	0x00	0x00	0x00	0x00	0x00	0x00	0x00	0x00	0x00	0x00	0x00
+208	<input type="text"/>	<input type="text"/>	<input type="text"/>	<input type="text"/>	<input type="text"/>	<input type="text"/>	<input type="text"/>	<input type="text"/>	<input type="text"/>	<input type="text"/>	<input type="text"/>	<input type="text"/>	<input type="text"/>	<input type="text"/>	<input type="text"/>	+208	0x00	0x00	0x00	0x00	0x00	0x00	0x00	0x00	0x00	0x00	0x00	0x00	0x00	0x00	0x00
+224	<input type="text"/>	<input type="text"/>	<input type="text"/>	<input type="text"/>	<input type="text"/>	<input type="text"/>	<input type="text"/>	<input type="text"/>	<input type="text"/>	<input type="text"/>	<input type="text"/>	<input type="text"/>	<input type="text"/>	<input type="text"/>	<input type="text"/>	+224	0x00	0x00	0x00	0x00	0x00	0x00	0x00	0x00	0x00	0x00	0x00	0x00	0x00	0x00	0x00
+240	<input type="text"/>	<input type="text"/>	<input type="text"/>	<input type="text"/>	<input type="text"/>	<input type="text"/>	<input type="text"/>	<input type="text"/>	<input type="text"/>	<input type="text"/>	<input type="text"/>	<input type="text"/>	<input type="text"/>	<input type="text"/>	<input type="text"/>	+240	0x00	0x00	0x00	0x00	0x00	0x00	0x00	0x00	0x00	0x00	0x00	0x00	0x00	0x00	[hex]

state: wait for transfer / last state: transmitting successfully completed

The bus monitor is the easiest way to manually send Modbus requests (e.g. to check the raw response of a slave). The monitor can be found on the page “system status” in the group “network applications”. If you want to open the monitor you just have to click on the “open monitor” button in

the line “Modbus monitor”. After clicking a pop up window will be shown. The content is divided to sender (left), receiver (right) and state (bottom). On the sender side you have to enter some parameters first: “slave” as target address, “function code” as commando for the Modbus function and “length” as length of the data. After entering a value in the “length” field the fields for the data gets enabled (every field represents one byte). If you have filled out all parameters you can click on the button “execute transfer” to transmit the entered data. After some seconds the state and maybe the received data will be shown.

12.1.2 RFC1006 protocol

For accessing the Modbus you can also use the network protocol RFC1006 (TCP port 102). At the “Connection Request” (CR) packet the source and destination TSAP must be equal to the characters “MB” (0x4D42). After sending the CR packet the EtherSens confirms with a “Connection Confirm” (CC) packet.

After the connection establishment “Data Telegram” (DT) packets can be sent. The data packets which are sent to the EtherSens must have the following structure:

0	1	2	3..*
slave no.	function code	length (0..252)	data (optional)

The replies from the EtherSens has the same structure as shown above. If a error occurs, the structure of the packet is as follows:

0	1	2
0xFF	0xFF	error code

The following list shows all available error codes:

code	description
1	invalid slave no < 0 or > 247
2	invalid length < 0 or > 252
3	transmission failed

4	no response received
5	space between characters to big
6	error in the parity
7	error in the checksum
8	response from wrong slave
9	frame too short
10	unknown

12.1.3 Process values

Additionally to the access via the bus monitor and RFC1006 the EtherSens has the possibility to send Modbus requests by itself. This is currently used to read or write process values.

If you want to define a Modbus process value you have to configure the Modbus slave first (Menu item “process” → “devices” → “client”). After that you can add the Modbus process value. The settings on this page were already explained in the chapter “Web server”.

The following function codes will be used by the EtherSens for reading or writing a process value:

data table	access mode	function code
Discrete Inputs	read	0x02
Discrete Outputs	read	0x01
Discrete Outputs	write	0x0F
Input Registers	read	0x04
Holding Registers	read	0x03
Holding Registers	write	0x10

12.2 Modbus slave

The EtherSens device can also work as Modbus slave. Thus the device waits for requests and process and answer them.

The devices from the EtherSens family are offering their process values via the table “Input Registers” (read only) and “Holding Registers” (read and write). Every process value of the EtherSens has a size of 4 bytes (32 bits). So the first value (index 0) will be addressed through the register 0x0000, the second (index 1) via 0x0002 and so on. But it is also possible to read or write only 16 bits of a process value.

Important:

Please note, that the register address depends on the process value index. If you don't know the index of a process value, please look at the process page on the web server.

The EtherSens devices are supporting the following function codes:

- 0x03 → Read multiple registers (“Holding Registers”).
- 0x04 → Read multiple registers (“Input Registers”).
- 0x06 → Write a single register (“Holding Registers”).
- 0x10 → Write multiple registers (“Holding Registers”).

Important:

If you send a write request via the function code 06h or 10h to the broadcast address, the value to write is accepted by the EtherSens but it will not respond.

13 EtherSens-Manager

The EtherSens-Manager is a Windows program (*requires Visual Studio C++ 2010 Redistributable x86*) which can be used to search for EtherSens devices in a network and change their configurations.

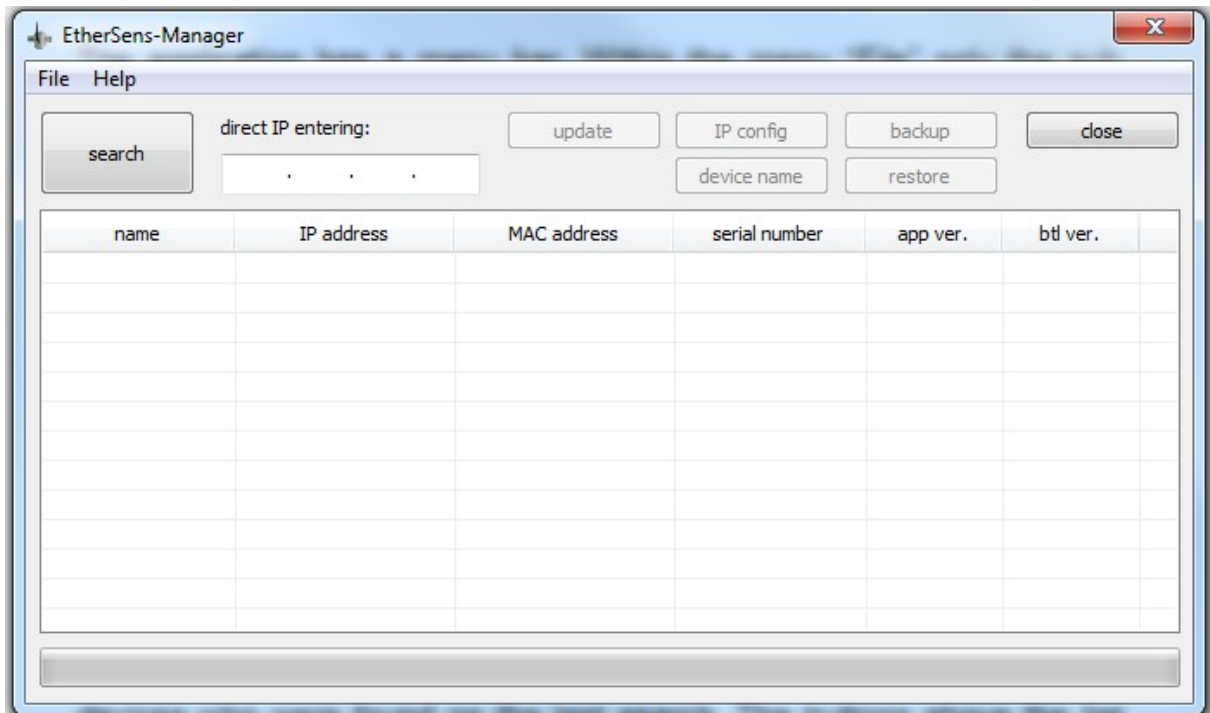

The application has a menu bar. Within the menu "File" only the sub menu item "Close" is located which can be used to close the application. This has the same effect as closing the program with the help of the X icon in the title bar. The menu "Help" consists of two sub menu items "Language" and "Info".

When clicking to the menu item "Language" a small window will appear in which the language of the program can be switched between "German" and "English". This configuration gets saved in the registry.



If you click on the menu item “Info” a dialog will be shown. In the dialog the name, version and copyright of the program gets displayed.



The main component of the window is the list view. The list shows all devices who were found on the last search. The buttons above the list belong to list and can be clicked if one of the devices in the list is selected.

13.1 Search for devices

If you want to search for EtherSens devices in the network you have to click on the big “search” button on the top left corner. After the search all devices which were found will be shown.

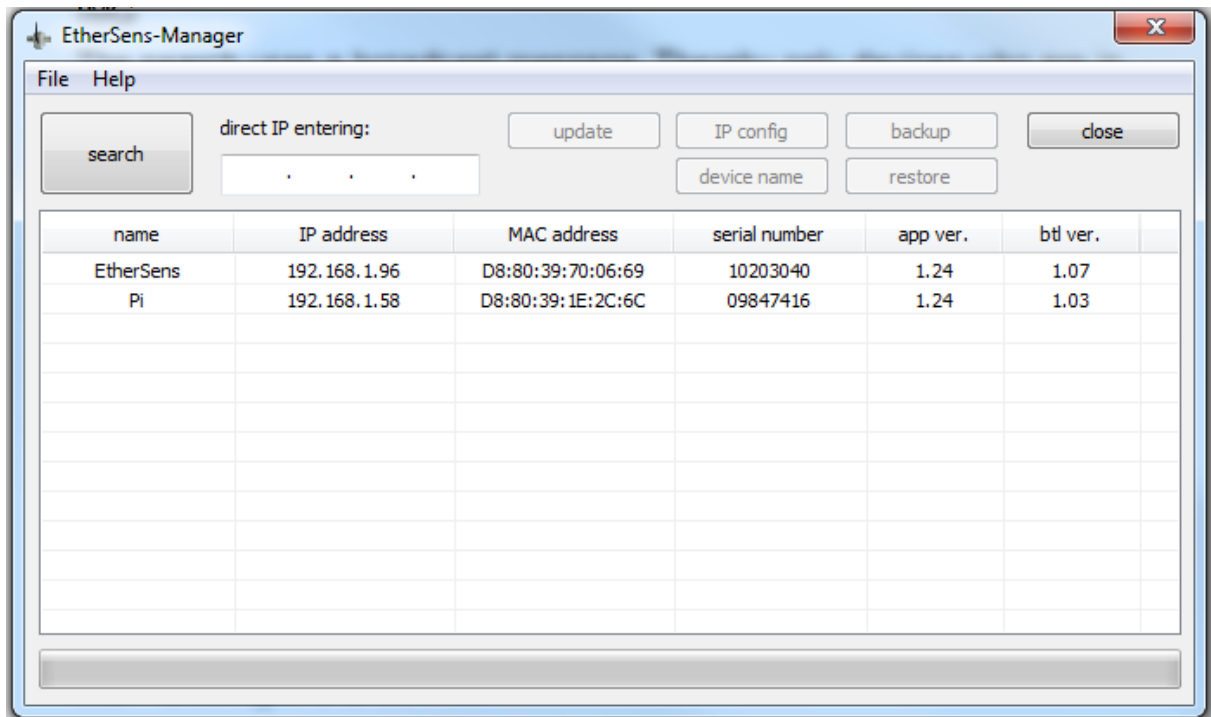

The search uses a broadcast message. Thereby only devices who are in the same physical subnet can be found. Devices who are located behind a router can't be found.

If you want to communicate with a EtherSens device which is behind a router (e. g. to update the firmware) you have to enter the IP address of the device in the field “direct IP entering”. Thereby a separated packet get sent to specified IP address after clicking on the “search” button.

Important:

If you couldn't find any device even if you have EtherSens devices in the same network, please verify that the firewall doesn't block the UDP port 293.

13.2 Configure a device

If you want to “work” with a single device (e. g. update it's firmware or change it's IP address) you have to select the device by clicking on the entry in the list view. After that the buttons “update”, “IP config”, “device name”, “backup” and “restore” are getting enabled.

The tasks which are described in the next topics needs that a device was selected.

If your device has a password you have to enter it in the following dialog before each action:

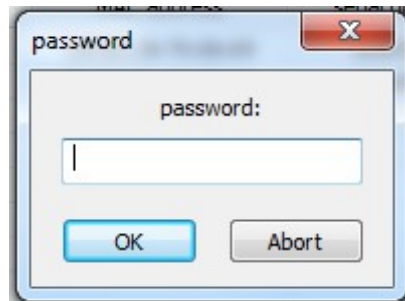

13.2.1 Firmware update

If you want to update the firmware of the EtherSens device you can click on the button “update” or execute a double click on the cell with the app version of the device. Afterwards a window will appear in which the firmware file can be selected.

The firmware file of the EtherSens device has the ending .hex and has to match the name pattern EtherSensVxyy.hex (x = version, yy = sub-version).

After you have selected a firmware file the update starts automatically. Thereby the file gets uploaded and the device does a restart do execute the update. The complete process takes about 1 to 2 minutes.

Important:

The update only works if the device is in the same subnet as your PC or behind a router.

13.2.2 IP configuration

To change the IP configuration of a device you have to click on the button “IP config” or double click on the IP address. After clicking a window will appear in which the IP configuration of the connected interface can be changed.

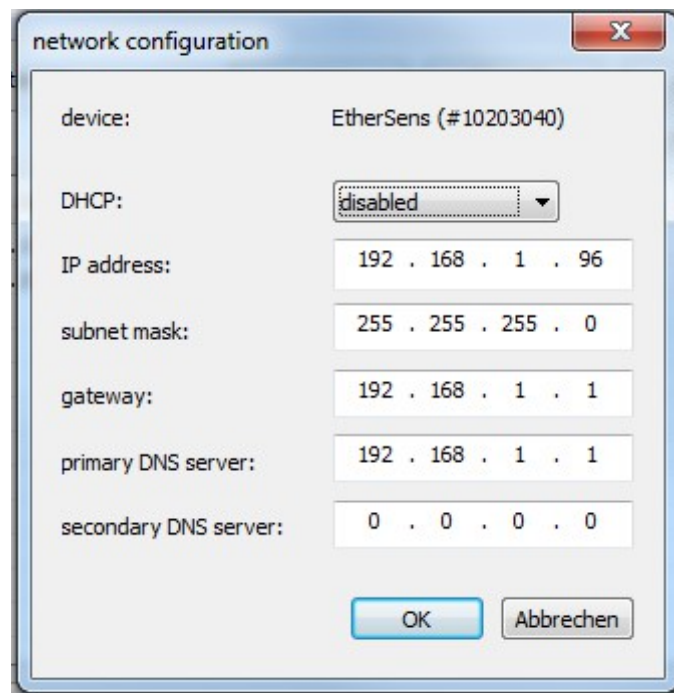

The following settings can be changed:

- | | |
|-------------------|--|
| DHCP: | disabled (without function)
DHCP client (device obtains a IP address from a DHCP server)
DHCP server (device distribute IP addresses to other devices) |
| IP address: | IP address of the device. |
| subnet mask: | Subnet mask of the device. |
| gateway: | IP address from the gateway. |
| prim. DNS server: | IP address from the primary DNS server. |
| sec. DNS server: | IP address from the secondary DNS server. |

After clicking on “OK” the settings gets send to the device and the device executes a restart. Afterwards the device is available under the new network configuration. The complete process takes about 10 to 20 seconds.

13.2.3 Device name

If you want to change the name of the device (the name is also used a netBIOS name) you can click on the button “device name”. Alternatively you could double click on the current device name in the list view. Afterwards a window gets shown:

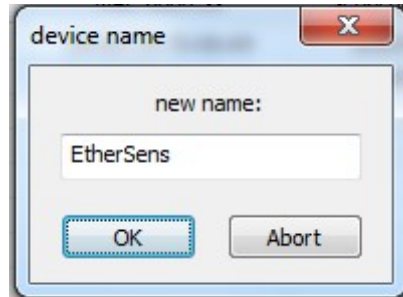

In the window you can type in the “new” name for the device. After clicking the “OK” button the name will be sent to the device and stored in the configuration.

13.2.4 Backup configuration

With the EtherSens-Manger you have the ability to create a backup of the complete configuration (user configuration and process list) of the device. To create such a backup you have to click on the button “backup”. After that you have to select the storage place (path and file name) and confirm the dialog. Now the configuration of the device gets transmitted and stored in the specified file.

13.2.5 Restore configuration

Of course it is possible to restore a saved configuration file. Therefore you just have to click on the “restore” button and choose the configuration file. After submitting the dialog the configuration gets transmitted to the device. If the transmission has completed the device gets restarted. This is necessary to submit all settings.

14 EtherSens CSV converter

The EtherSens CSV converter is a Windows program (*requires .NET Framework 3.5 or higher*), which can be used to convert the binary record files (with the file extension .bin or .bak) from a EtherSens or **MONI** device to a readable CSV file.

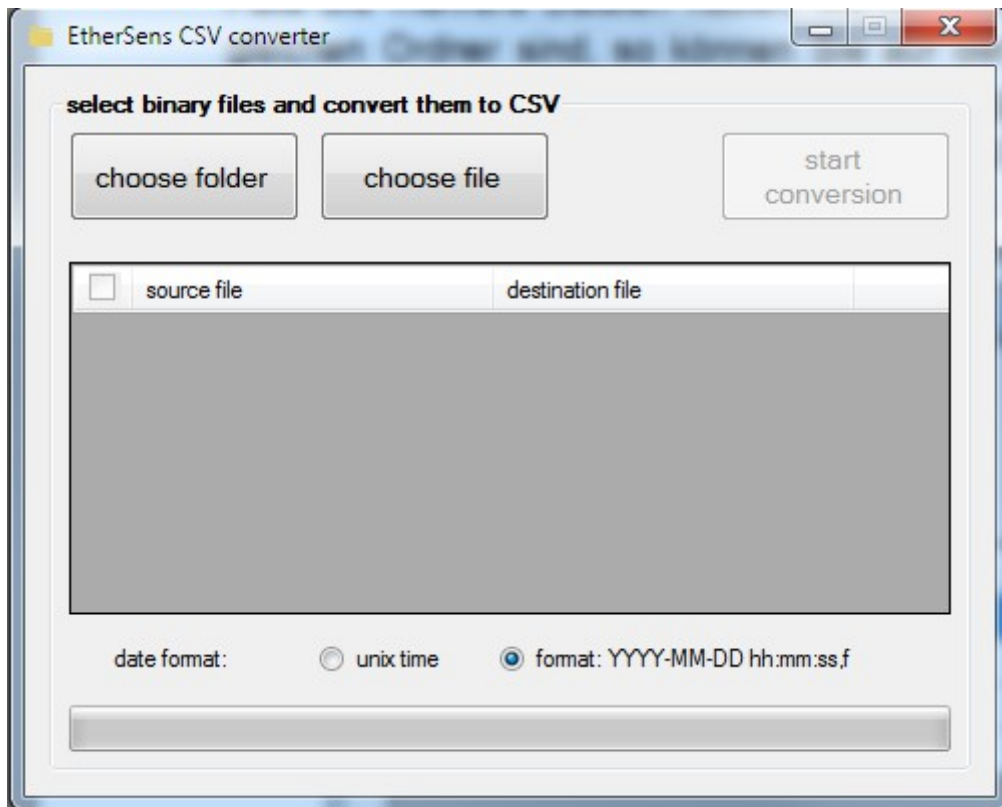

The interface of the CSV converter is really simple and consists mostly of a file list. But more on that later.

The dialog to configure the language as well as the info dialog can be opened via the context menu of the application. To open the context menu you just have to click on the icon on the title bar with the left mouse button or on any place on the title bar with the right mouse button.

If you want to change the language of the program you have to click on the entry "Sprache / Language" of the context menu. The language setting will be saved within the user settings.

If you want to open the info dialog you can click on the entry “Info about EtherSens CSV converter” in the context menu. The info dialog shows, among other things, the version number. This can be helpful for the technical support if you have questions or problems.

14.1 select files

Before you can start with the conversion of the files into the CSV format, you have to specify the files which should be converted.

If you have multiple files which should be converted and where are within the same folder, you can click on the button “choose folder”. Now you should see the default Windows dialog for selecting a folder. After you have submitted your selection the program searches for .bin and .bak files and checks their formats. If the file is valid it will be added to the list.

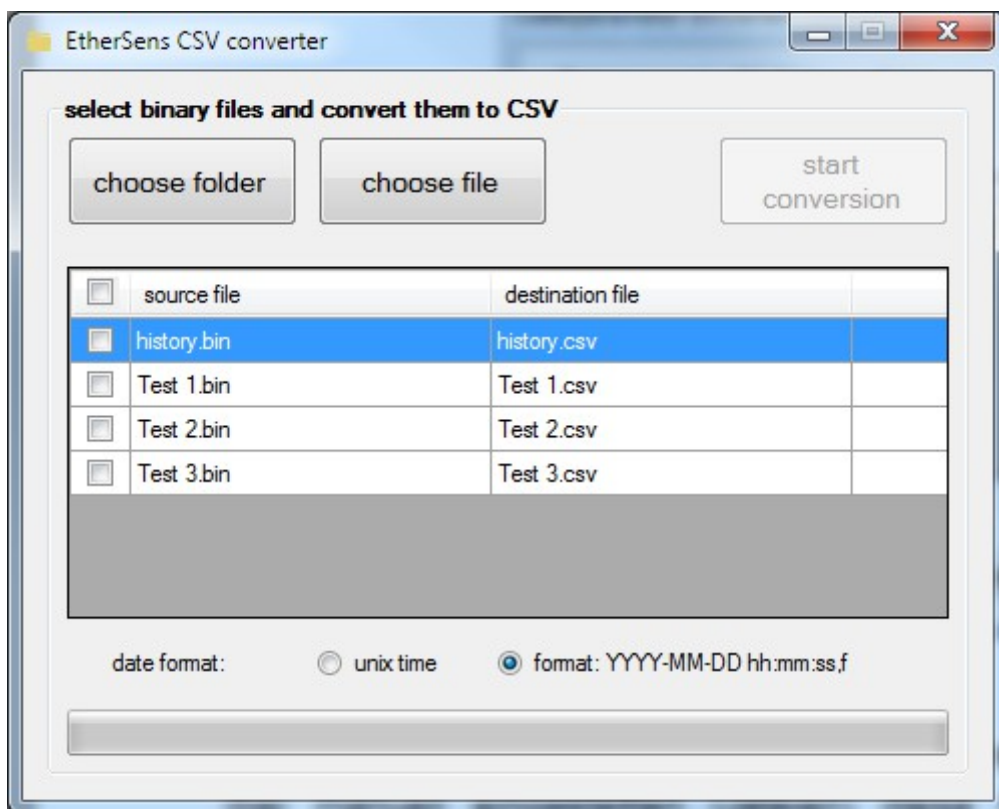

Important:

Please note, that the selection of a folder resets the complete file list. This means that it isn't possible to select two folders on the same run through.

If you want to add a single file to the list, you can click on the button “choose file”. After you have clicked on the button you will be able to select a .bin or .bak file. In the next step the file format will be checked. If the file has a valid format it will be added to the list.

If the format of the file can't be determined, a dialog appears, which allows you to specify the number of process values and their formats. This procedure is necessary if you want to convert a history file, which was generated from a device with a firmware version older than 1.22.

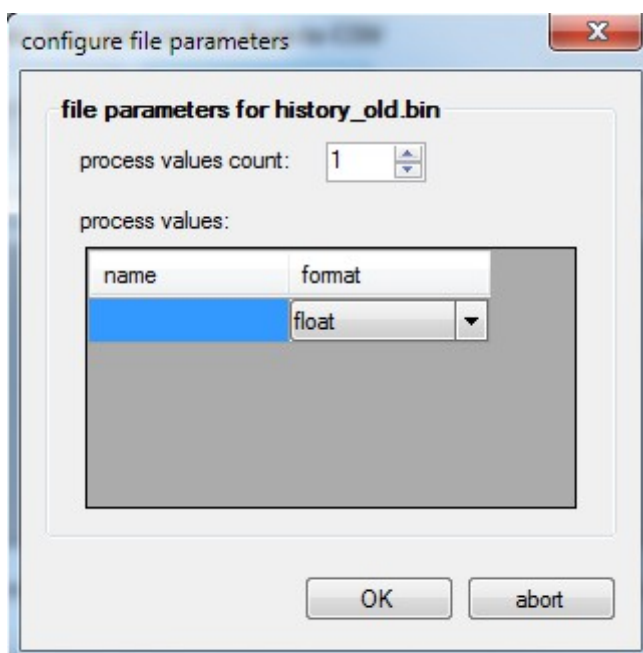

For each file which has a valid format the application will check if a .nam file for the corresponding .bin or .bak file is available. These files are stored on the SD card for a combined history additionally, if the setting “name file” on the web server in the menu item system → storage is enabled, and contain the names of the recorded process values.

If you want to view or change the parameters of a file you have to double click on the name of the source file. Thereby a dialog will be shown where you can specify the number of process values as well as their names and formats. For files where a valid format was automatically detected the fields for the number of process values as well as their formats can't be edited. The fields for the process value names can be edited at any time, independent if a name files was found or not.

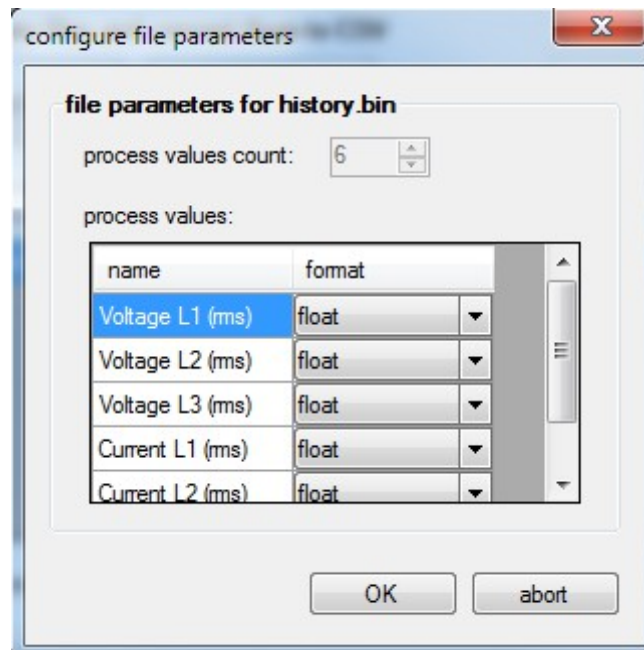

Hint:

The entering of the names for the process values is optional. If no names are entered the resulting CSV file will just not contain a header line.

14.2 convert files

If you are finished with selecting a folder and files, you can decide which files should be converted to CSV format. Therefore every entry on the file list has a check box on the front of the entry. If the check box is checked the file will be converted. With the help of the check box on the head line of the file list you can (de)select all entries.

If you have made your decision you can specify which date format should be used for the timestamps in the CSV file. The available formats are the same as the formats in the EtherSens device for the direct CSV recording.

Please note that the date format “unix time” is using a timestamp in milliseconds and not, as regularly used, in seconds. For direct further processing or formatting in programs like Microsoft Excel a previously division by 1000 may be needed. If you want to convert a timestamp to a human readable date manually, you can use one of the on the internet available converter tools (e. g. www.unixtimestamp.com) after you have cut off the last 3 digits.

Now that you have set all settings you can start the conversion. Therefore you just have to click on the button “start conversion”.

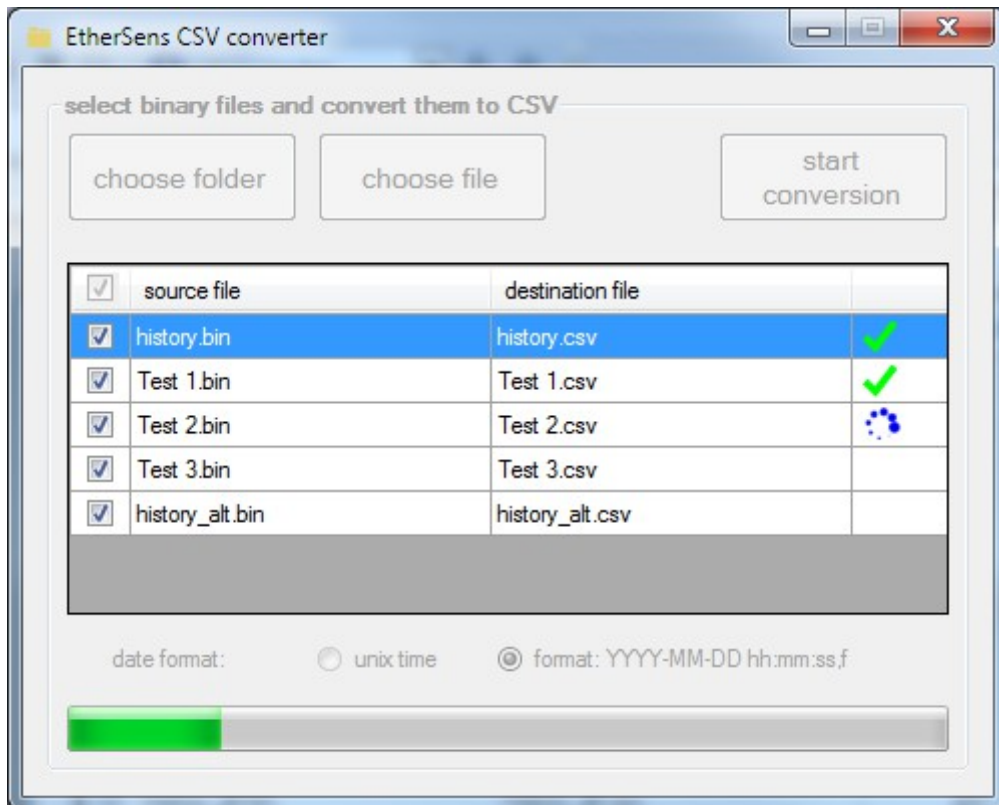

The icon on the last column of every entry shows the state of the conversion. The progress bar shows the progress of the current file.

15 Hardware

In this chapter external hardware components which can be connected to the EtherSens are described in more detail. The communication between the device and the external hardware runs with an external I2C bus. The external I2C bus can be provided by the EtherSens device.

If you look for the hardware description of a EtherSens device please look at the chapters “Description of each device”, “Connection” and “Technical data”.

15.1 LED segment

The LED segment component consists of 4 14 segment displays (+ dot). The 4 pins on the right side (see image) are needed to connect the module with the external I2C bus of the EtherSens device.



I2C-Adresse des Moduls
I2C-address of the module

Important:

Please pay attention to the cabling of the 4 pins. Connecting the wrong pins can destroy the module.

Each of the 4 “characters” have it's own process value in the configuration of the EtherSens device. The organization of one letter looks like the following:

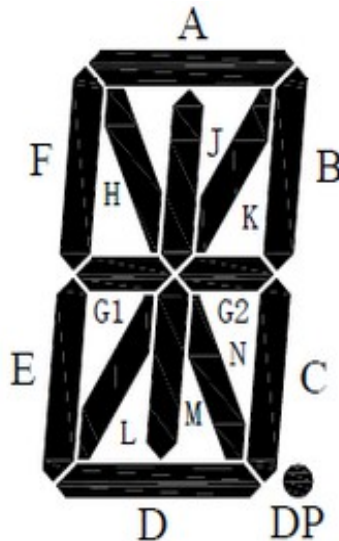

To switch segments on or off you always have to write the complete value of the letter. Every segment is represented as a single bit within a 16 bit value (most significant bit is always 0). The structure of the value is as follows:

0 D P N M L K J H G 2 G 1 F E D C B A

If you want to enable the segment “A” you will need the value 0x0001. The value 0x0008 cause that segment “D” is lighting. To switch off all segments you can write the value 0x0000. With the value 0x7FFF all segments will light.

16 Usage examples

16.1 Usage examples EtherSens *MONI* and Energy

16.1.1 3-phase consumer

The measurements for the voltages occur directly via the connected phases L1, L2, L3. The current is measured with on the sensor inputs connected folding-cores or Rogowski coils. From that the EtherSens device can calculate the power and energy.

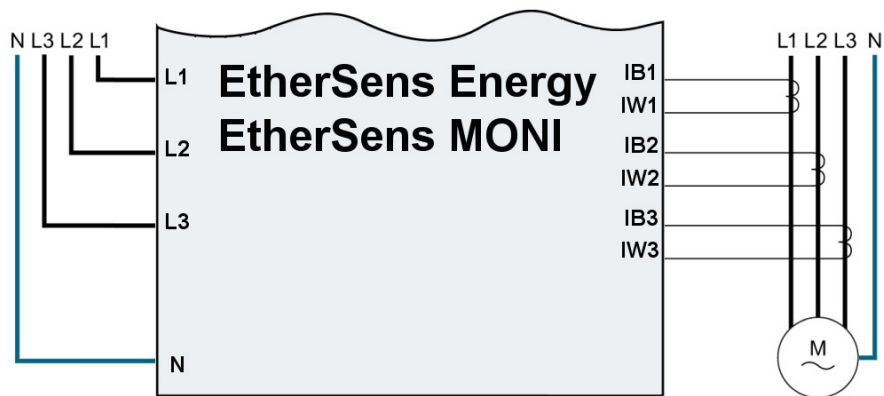

Of course you can only connect L1 and N (power supply for the device itself) but connect all three sensors for the current measurement. In this operating mode the power and energy can't be calculated correctly because the voltage for L2 and L3 are missing. The captures for the currents are working, because they are independent of the voltage.

16.1.2 1-phase consumer

The measurement of the voltage occurs via the input L1 and N. The folding-core or Rogowski coil must be connected to the first sensor input. From that the EtherSens device can calculate the power and energy for one phase (L1).



16.1.3 Consumer without a neutral conductor

The measurements for the voltages occur directly via the connected phases L1, L2, L3. The current is measured with on the sensor inputs connected folding-cores or Rogowski coils. From that the EtherSens device can calculate the power and energy.

With an earthed neutral conductor and a negligible load the N-pin of the EtherSens device can be connected to PE (earth).

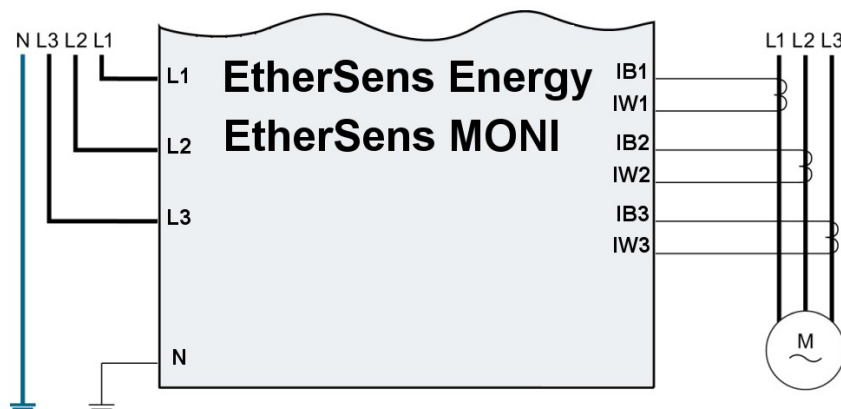

17 Description of each device

17.1 Description EtherSens *MONI*

EtherSens *MONI* is an mobile netanalyser for EN 50470-1 / EN 50470-3. With this device you will able to capture currents as well as powers and energies with the connected sensors. The captured data can be written to a microSD card (not included in the scope of delivery) or via the FTP-protocol to an FTP-server.

The device can be supplied with following sources:

- 230VAC from L1 + N
- 24VDC external supply
- USB of the PC and also power-pack

Attention:

When using the power supply of 5V from the USB port of your PC please pay attention to the maximum current of 500mA of this port, when you have connected an other device on the USB_OUT port.

Please do not connect Rogowski coils which aren't released by your distribution partner. No liability is accepted for any damages.

When you are not sure if you have the correct folding-cores or Rogowski coils you can contact our support.

Hint:

The devices are factory calibrated and can be used directly. A new calibration is only needed when the conductor is wrapped around the coil multiple times or when other Rogowski coils or folding-cores are used.

17.2 Description EtherSens Energy

EtherSens Energy is an offshoot of the big EtherSens family. The devices of the EtherSens family are universal devices for recording and capturing measurement variables.

The EtherSens Energy is a device to capture currents as well as powers and energies with the connected sensors. The captured data can be written to a microSD card (not included in the scope of delivery) or via the FTP-protocol to an FTP-server.

The device can be plugged on a din-rail (EN 50022). To change settings or check the state of the device you can use the web server which is integrated in the EtherSens device.

The device is available in two versions:

Art. No.	description
9202	EtherSens Energy for folding cores
9203	EtherSens Energy for Rogowski coils

Attention:

Please do not connect Rogowski coils to a folding-core device or the other way around. No liability is accepted for any damages.

When you are not sure if you have the correct folding-cores or Rogowski coils you can contact our support.

Hint:

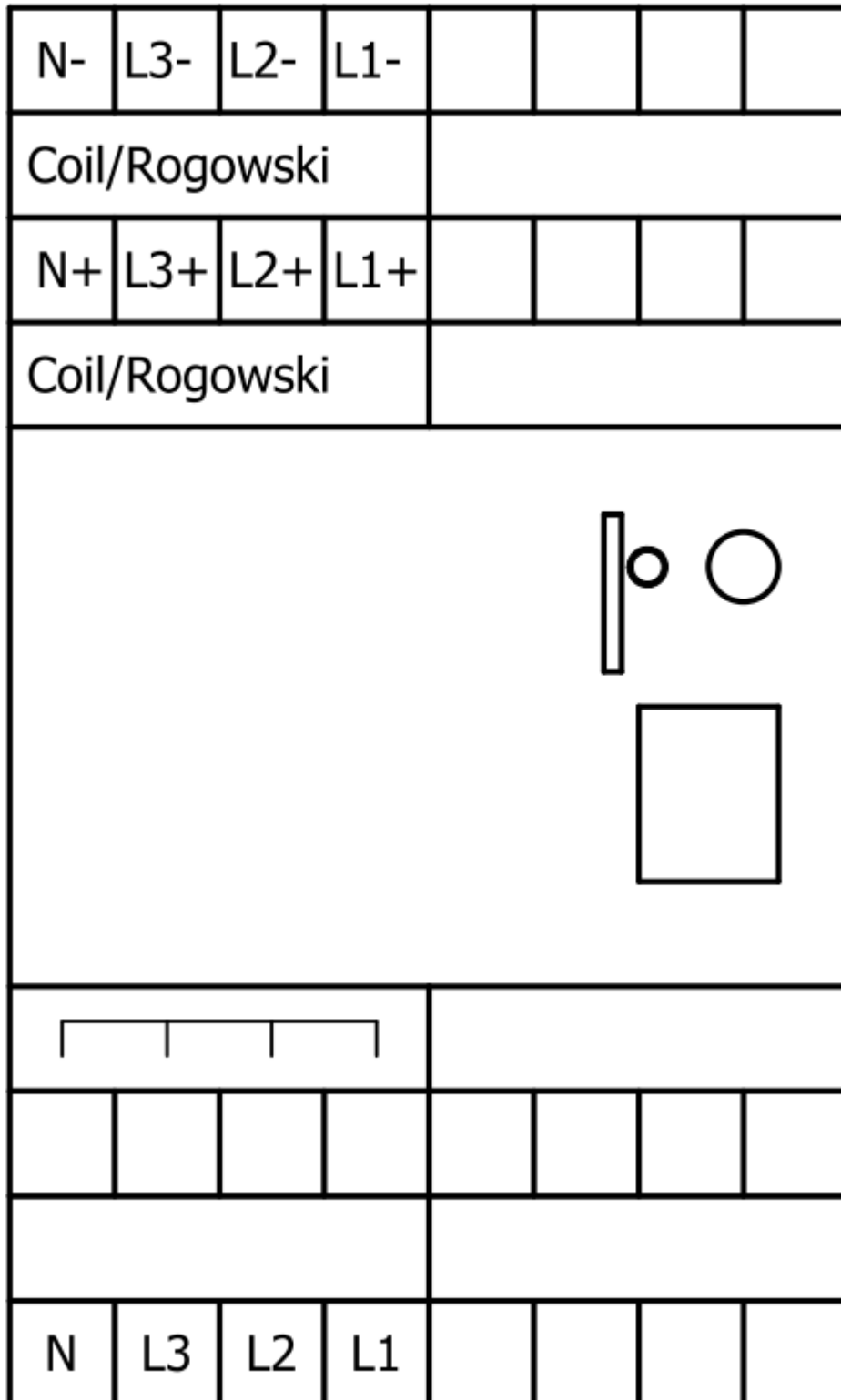

The devices are factory calibrated and can be used directly. A new calibration is only needed when the conductor is wrapped around the coil multiple times or when other Rogowski coils or folding-cores are used.

17.2.1 Port assignment EtherSens Energy



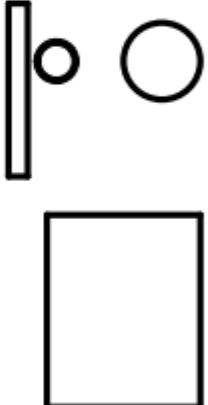

(View to the device)

17.2.2 Port assignment EtherSens Energy + Analog-IO

N-	L3-	L2-	L1-	24V	0V	0V	0V
Coil/Rogowski							
N+	L3+	L2+	L1+	1	2	3	4
Coil/Rogowski				Analog-IN			
							
				Analog-OUT			
				1+	2+	3+	4+
				Analog-OUT			
N	L3	L2	L1	1-	2-	3-	4-

(View to the device)

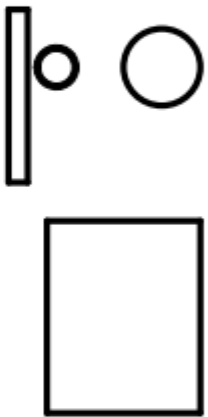
17.2.3 Port assignment EtherSens Energy + Digital-IO

N-	L3-	L2-	L1-	24V	0V		
Coil/Rogowski							
N+	L3+	L2+	L1+	1	2	3	4
Coil/Rogowski				Digital-IO			
							
				Digital-IO			
				5	6	7	8
				Digital-IO			
N	L3	L2	L1	9	10	11	12

(View to the device)

17.3 Description EtherSens Control

EtherSens Control is an offshoot of the big EtherSens family. The Control device includes analog and digital inputs and outputs.

The device is delivered with the following configuration:

12x Digital-I/O	input: max. 24V DC output: max. 24V DC, max. 400mA (via the web server every pin can be defined as input or output)
4x Analog-IN (HW 1.0)	measurement to GND with 0-0.25V, 0-0.5V, 0-1V, 0-2V, 0-4V, 0-5 V switchable within the device or 0-20mA with an external shunt (250 Ohm) measurement from Ain1 to Ain2 and from Ain3 to Ain4 with $\pm 0.25V$, $\pm 0.5V$, $\pm 1V$, $\pm 2V$, $\pm 4V$, $\pm 5V$
4 x Analog-IN (HW 1.1)	measurement to GND with 0-0.25V, 0-0.5V, 0-1V, 0-2V, 0-4V, 0-5V, 0-10V, 0-20V, 0-40V, 0-50V, 0-20mA, 4-20mA switchable within the device measurement from Ain1 to Ain2 and from Ain3 to Ain4 with $\pm 0.25V$, $\pm 0.5V$, $\pm 1V$, $\pm 2V$, $\pm 4V$, $\pm 5V$, $\pm 10V$, $\pm 20V$, $\pm 40V$, $\pm 50V$
4x Analog-OUT	0/4-20mA (from +_pin to -_pin)

Attention:

Switching an as input-configured-digital-IO-pin with respect to ground to an output causes a short circuit and furthermore corrupt the device.

If you want to connect a relay please pay attention to the quenching-diode including the correct polarity.

The EtherSens control is available in different versions including 4 versions with integrated relays for 230VAC/16A:

Art. No.	description	power supply
9200-A-24V	Control 24V Analog-IO	24VDC
9200-AA-24V	Control 24V 2x Analog-IO	24VDC
9200-D-24V	Control 24V Digital-IO	24VDC
9200-DD-24V	Control 24V 2x Digital-IO	24VDC
9200-AD-24V	Control 24V Analog-/Digital-IO	24VDC
9200-R-24V	Control 24V Relay-IO	24VDC
9200-AR-24V	Control 24V Analog-/Relay-IO	24VDC
9200-DR-24V	Control 24V Digital-/Relay-IO	24VDC
9200-R-230V	Control 230V Relay-IO	230VAC

17.3.1 Port assignment EtherSens Control HW 1.0

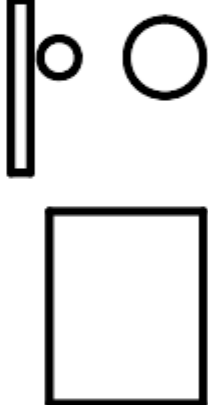
12	11	10	9	24V	0V	0V	0V
Digital-I/O							
8	7	6	5	1	2	3	4
Digital-I/O				Analog-IN			
							
				Analog-OUT			
0V			24V	1+	2+	3+	4+
Digital-I/O				Analog-OUT			
4	3	2	1	1-	2-	3-	4-

(View to the device)

17.3.2 Port assignment EtherSens Control HW 1.1

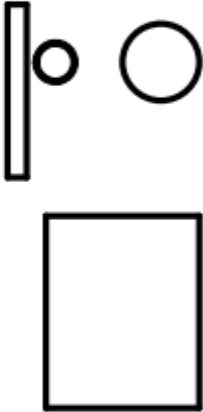
12	11	10	9	24V	0V	0V	0V
Digital-IO							
8	7	6	5	1	2	3	4
Digital-IO				Analog-IN			
							
Digital-IO				Analog-OUT			
4	3	2	1	1+	2+	3+	4+
				Analog-OUT			
		0V	24V	1-	2-	3-	4-

(View to the device)

17.3.3 Port assignment EtherSens Control Relay (230VAC)

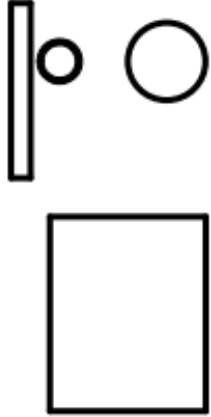
L	N	0V	24V				
AC-IN		DC-OUT					
							
K2		K1					
N.O.	C	N.O.	C				
K4		K3					
N.O.	C	N.O.	C				

(View to the device)

17.3.4 Port assignment EtherSens Control Relay (24VDC)

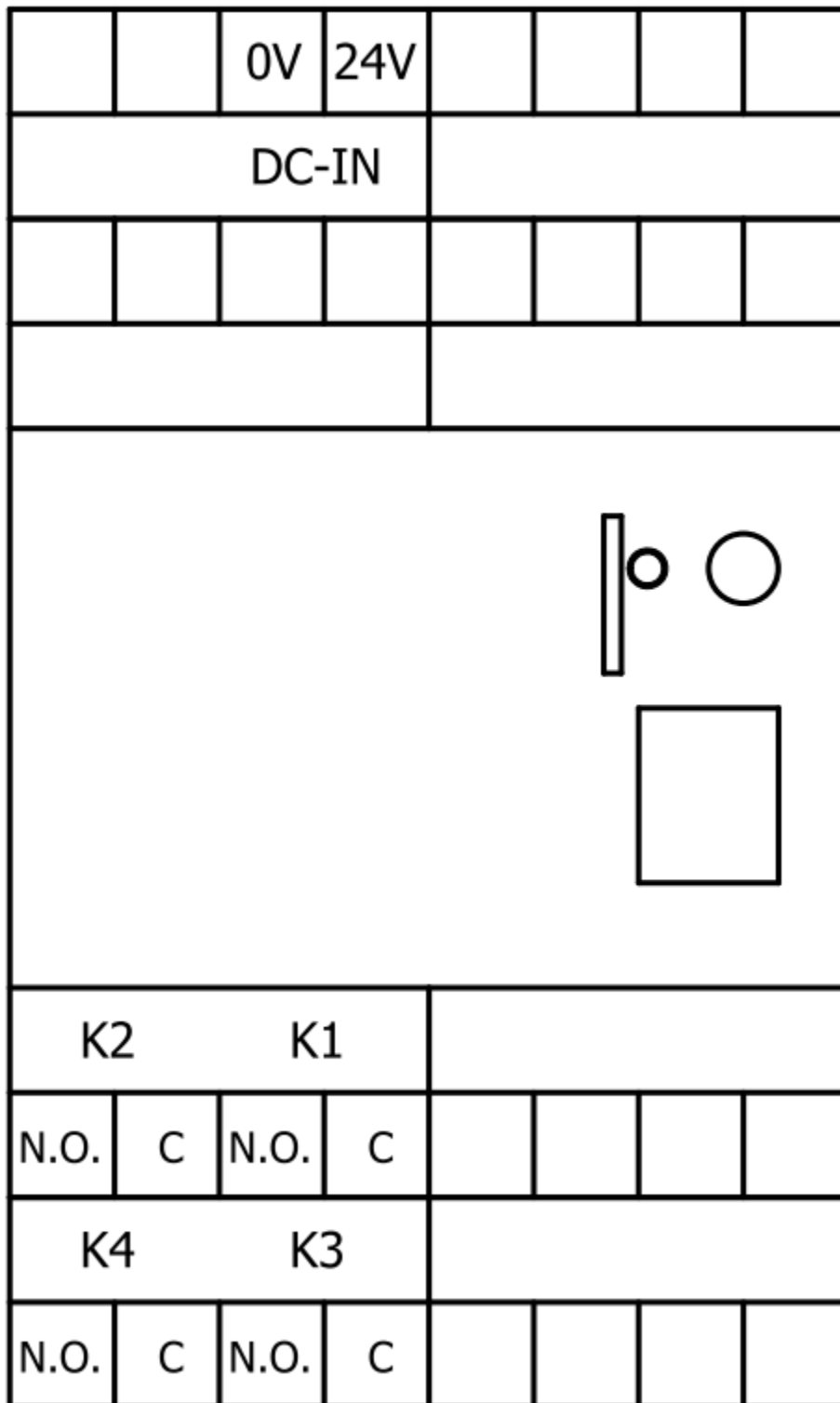

(View to the device)

17.4 Description EtherSens Basic

The EtherSens Basic is an offshoot of the big EtherSens family. The EtherSens Basic device allows you to communicate between LAN and WLAN.

You have to configure the WLAN and LAN settings separately. Therefore both devices needs an own IP address. The IP address of the interfaces have to be different.

To activate the bridging function you have to navigate to the menu item “system” → “network and WiFi” and activate the function “network bridging”. Afterwards you have to click on the “save” button and the device will execute a restart.

	WLAN	LAN
DHCP setting:	DHCP server ▾	DHCP server ▾
IP address:	192.168.1.58	192.168.1.59
subnet mask:	255.255.255.0	255.255.255.0
gateway:	192.168.1.1	192.168.1.1
primary dns server:	192.168.1.1	192.168.1.1
secondary dns server:	0.0.0.0	0.0.0.0
network bridging:	<input checked="" type="checkbox"/> enable	

Attention:

The operation mode „network bridging“ isn’t a full-fledged replacement for a WiFi router. The throughput is maximum 3MBit/s!

17.4.1 Port assignment EtherSens Basic

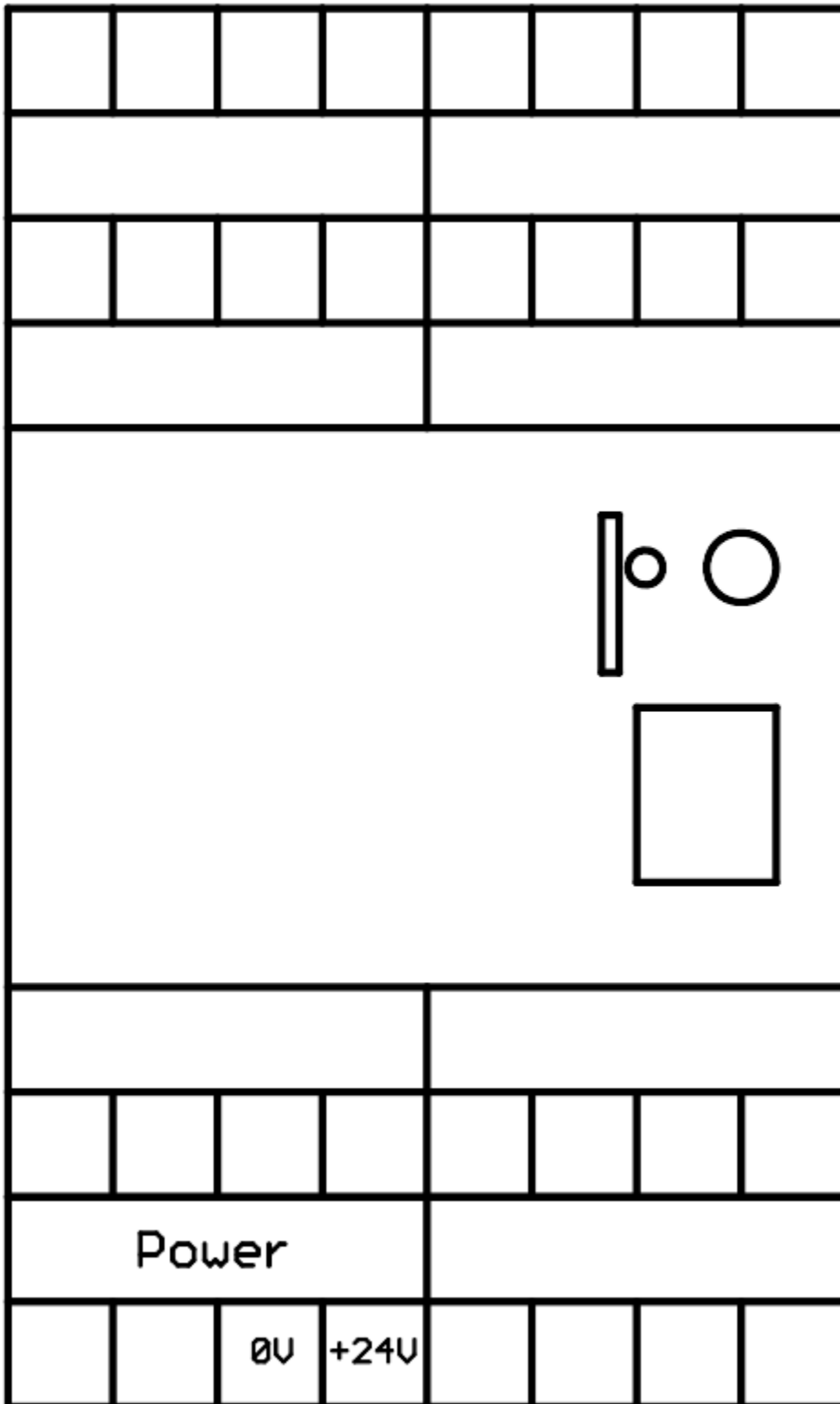

(View to the device)

18 Description of each option

Some functions on the devices of the EtherSens family are only available via an option, which can be bought and activated through a chargeable license.

If you want to know which options are activated on your device you can go to the page “system” on the web server of the device. The group “licensing” shows you the current state of the options:

licensing	
PLC messages with additional text:	licensed

18.1 PLC messages with additional text

With this option you have the possibility to define additional texts for the PLC messages which should be send via an e-mail in front of the content from your PLC.

The using of additional texts is only possible in combination with e-mail sending. Because the additional texts are stored on the SD card, it is necessary that a SD card is plugged in to your device. If you have activated this option you can still send a PLC message without an additional text.

You are interested in one of the options? Please contact your distribution partner.

19 Connection

19.1 Connection EtherSens *MONI*

The EtherSens *MONI* device must be connected as follows:

power supply and voltage measurement:

Front	pin N:	connect the N-conductor
Front	pin L1:	connect phase L1 <i>(power supply for the device)</i>
Front	pin L2:	connect phase L2
Front	pin L3:	connect phase L3
<i>or</i>		
Rear	+24V:	external 24V DC
Rear	0V:	GND of external 24V
<i>or</i>		
Rear	USB_IN:	5V DC from PC or power-pack <i>(Please note maximum current!)</i>

Rogowski coils:

coil 1 (phase L1): Push-pull-connector L1	pin 1:	black braid of the coil
	pin 2:	white braid of the coil
	pin 4:	shield of coil-cable
coil 2 (phase L2): Push-pull-connector L2	pin 1 :	black braid of the coil
	pin 2:	white braid of the coil
	pin 4:	shield of coil-cable
coil 3 (phase L3): Push-pull-connector L3	pin 1 :	black braid of the coil
	pin 2:	white braid of the coil
	pin 4:	shield of coil-cable
coil 4 (N-conductor, optional): Push-pull-connector N	pin 1 :	black braid of the coil
	pin 2:	white braid of the coil
	pin 4:	shield of coil-cable

Important:

The shields from the connection cable of the coils have to be connected to earth. Furthermore the flow direction of the coils should be respected. Otherwise the power (apparent and reactive power) and phase angle values are incorrect.

Connection graphic Rogowski coil:

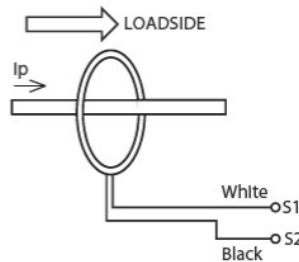

USB connectors:

USB-OUT: With this connector you would be able to load a power-pack while the device is running. A maximum current of 500mA is provided. By supply the device with USB_IN the current is reduced to maximum 200mA. Please note before connecting.

19.2 Connection EtherSens Energy

The EtherSens Energy device must be connected as follows:

power supply:

clamp „voltage“
clamp „voltage“

pin N: connect the N-conductor distributor: This clamp can be used as a busbar application

voltage measurement:

clamp „voltage“

pin L1: connect phase L1
(power supply for the device)

clamp „voltage“

pin L2: connect phase L2

clamp „voltage“

pin L3: connect phase L3

folding cores:

sensor 1 (phase L1):

clamp „coil“	pin IK1:	To the K-pin of the folding-core
clamp „coil“	pin IL1:	To the L-pin of the folding-core

sensor 2 (phase L2):

clamp „coil“	pin IK2:	To the K-pin of the folding-core
clamp „coil“	pin IL2:	To the L-pin of the folding-core

sensor 3 (phase L3):

clamp „coil“	pin IK3:	To the K-pin of the folding-core
clamp „coil“	pin IL3:	To the L-pin of the folding-core

sensor 4 (N-conductor, optional):

clamp „coil“	pin IKN:	To the K-pin of the folding-core
clamp „coil“	pin ILN:	To the L-pin of the folding-core

Rogowski coils:

coil 1 (phase L1):

clamp „rogowski“	pin IB1:	black braid of the coil
clamp „rogowski“	pin IW1:	white braid of the coil

coil 2 (phase L2):

clamp „rogowski“	pin IB2:	black braid of the coil
clamp „rogowski“	pin IW2:	white braid of the coil

coil 3 (phase L3):

clamp „rogowski“	pin IB3:	black braid of the coil
clamp „rogowski“	pin IW3:	white braid of the coil

coil 4 (N-conductor, optional):

clamp „rogowski“	pin IBN:	black braid of the coil
clamp „rogowski“	pin IWN:	white braid of the coil

Important:

The shields from the connection cable of the coils have to be connected to earth. Furthermore the flow direction of the folding-cores and coils should be respected. Otherwise the power (apparent and reactive power) and phase angle values are incorrect.

Connection graphic Rogowski coil:

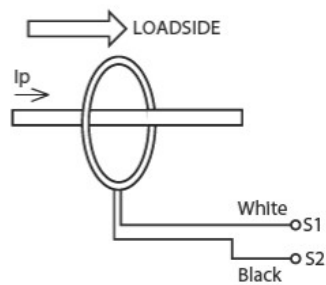

19.3 Connection EtherSens Control

The EtherSens Control device must be connected as follows:

power supply:

clamp „Power“	pin +24V:	24VDC supply
clamp „Power“	pin 0V:	GND

19.3.1 Connection EtherSens Control Relay (230VAC)

The EtherSens Control Relay device with a power supply of 230VAC must be connected as follows:

power supply:

clamp „Power“	pin L:	230VAC supply
clamp „Power“	pin N:	neutral conductor

The device outputs a voltage of 24VDC on the pins “24V” and “GND”.

19.3.2 Connection EtherSens Control Relay (24VDC)

The EtherSens Control Relay device with a power supply of 24VDC must be connected as follows:

power supply:

clamp „Power“	pin +24V:	24VDC supply
clamp „Power“	pin 0V:	GND

19.4 Connection EtherSens Basic

The EtherSens Basic device must be connected as follows:

power supply:

clamp „Power“	pin +24V:	24VDC supply
clamp „Power“	pin 0V:	GND

20 Technical data

20.1 Technical data EtherSens *MONI*

Supply voltage:	230VAC +/- 10% (from L1 + N) 24V DC (over detachable connector) USB (from PC/power-pack)
Power consumption:	5 watt
Display:	Web server 1 status LED bi-color
Handling/Configuration:	Web server
Interfaces:	Slot for microSD card 4x voltage socket 4mm (L1, L2, L3, N) 4x sensor input 4pin push-pull (each phase + N) USB_IN socket type B-mini USB_OUT socket type A Button for factory settings Antenna-connector GSM/FME(m) 2.4 GHz IEEE 802.11b/g 10/100BaseTX RJ45 Ethernet plug
Overvoltage category:	CAT IV
Insulation value network <=> mains voltage:	1,5 KV
Operating temperature:	5 - 55°C
Case:	ABS plastic case
Dimensions:	115 x 95 x 30 mm

20.2 Technical data EtherSens Energy

Supply voltage:	230VAC +/- 10%
Power consumption:	6 watt
Display:	Web server 1 status-LED bi-color
Handling/Configuration:	Web server
Interfaces:	Slot for microSD card 4x voltage input (L1, L2, L3, N) 4x sensor input (L+K- / B+W-clamp each phase + N) 4x terminal clamp Button for factory settings Antenna-connector GSM/FME(m) 2.4 GHz IEEE 802.11b/g 10/100BaseTX RJ45 Ethernet plug
Overvoltage category:	CAT IV
Insulation value network <=> mains voltage:	1,5 KV
Operating temperature:	5 - 55°C
Case:	ABS plastic case
Dimensions:	100 x 112 x 45 mm

20.3 Technical data EtherSens Control

Supply voltage:	24VDC +/- 10% 230VAC +/-10 % for EtherSens Control 230V Relay-IO
Power consumption:	3 watt (without switched outputs)
Display:	Web server 1 status-LED bi-color
Handling/Configuration:	Web server
Interfaces:	<p>Slot for microSD card</p> <p>12x Digital-IO switchable as</p> <ul style="list-style-type: none"> • input (24VDC max. 8k2 (pull up external) / min 1.6mA) or • output (24VDC 400mA) <p>4 x Analog inputs 0-5V (HW 1.0)</p> <ul style="list-style-type: none"> • measurement to GND with 0-0.256V, 0-0.512V, 0-1.204V, 0-2.048V, 0-4.096V, 0-6.144V or • measurement from Aln1 to Aln2 and from Aln3 to Aln4 with $\pm 0.256V$, $\pm 0.512V$, $\pm 1.204V$, $\pm 2.048V$, $\pm 4.096V$, $\pm 6.144V$ or • optional with external shunt 0/4-20mA • optional with external voltage divider 0-10/24/50V <p>4 x Analog inputs (HW 1.1)</p> <ul style="list-style-type: none"> • measurement to GND with 0-0.25 V, 0-0.5 V, 0-1 V, 0-2 V, 0-4 V, 0-5 V, 0-10 V, 0-20 V, 0-40 V, 0-50 V, 0-20mA, 4-20mA switchable within the device • measurement from Aln1 to Aln2 and from Aln3 to Aln4 with $\pm 0.25 V$, $\pm 0.5 V$, $\pm 1 V$, $\pm 2 V$, $\pm 4 V$, $\pm 5 V$, $\pm 10 V$, $\pm 20 V$, $\pm 40 V$, $\pm 50 V$ <p>4 x Analog outputs 0/4-20mA (source voltage 24V)</p> <p>Button for factory settings</p> <p>Antenna-connector GSM/FME(m) 2.4 GHz IEEE 802.11b/g</p> <p>10/100BaseTX RJ45 Ethernet plug</p>
Overvoltage category:	CAT IV
Insulation value network \Leftrightarrow mains voltage:	1,5 KV
Operating temperature:	5 - 55°C
Case:	ABS plastic case

Dimensions:	100 x 112 x 45 mm

20.4 Technical data EtherSens Basic

Supply voltage:	24VDC +/- 10%
Power consumption:	2 watt
Display:	Web server 1 status-LED bi-color
Handling/Configuration:	Web server
Interfaces:	Slot for microSD card Button for factory settings Antenna-connector GSM/FME(m) 2.4 GHz IEEE 802.11b/g 10/100BaseTX RJ45 Ethernet plug
Overvoltage category:	CAT IV
Insulation value network <=> mains voltage:	1,5 KV
Operating temperature:	5 - 55°C
Case:	ABS plastic case
Dimensions:	100 x 112 x 45 mm

21 Appendix

21.1 Example codes for TCP process server

21.1.1 PHP code

```
<?php
// create socket
if (($socket = socket_create(AF_INET, SOCK_STREAM, SOL_TCP)) !== false)
{
    // connect to EtherSens
    if (socket_connect($socket, "192.168.1.59", "65535") !== false)
    {
        // send request for reading the process value with the index 0
        if (socket_write($socket, "\x00\x00\x3F") !== false)
        {
            // receive response
            if (($resp = socket_read($socket, 3)) !== false)
            {
                // check if data follos
                if ($resp[2] === "\x3D")
                {
                    if (($resp = socket_read($socket, 4)) !== false)
                        echo "value from process value 0: "
.dechex(reset(unpack("i", $resp)));
                    else
                        echo "data for process value 0 couldn't be
received";
                }
                else
                    echo "process value 0 couldn't be read";
            }
            else
                echo "read response for process value 0 couldn't be
received";
        }
        else
            echo "read request for process value 0 couldn't be send";

        echo "<br />";

        // send request for writing the process value with the index 1
        (value 0xA1B2C3D4)
        if (socket_write($socket, "\x00\x01\x21\xD4\xC3\xB2\xA1") !==
false)
        {
            // receive response
            if (($resp = socket_read($socket, 3)) !== false)
            {
                // check if the process value could be written
                if ($resp[2] === "\x2B")
                    echo "process value 1 was written";
                else
                    echo "process value 1 couldn't be written";
            }
            else
                echo "write response for process value 1 couldn't be
received";
        }
    }
}
```

```
        else
            echo "write request for process value 1 couldn't be send";
    }
    else
        echo "connection couldn't be established";
}
else
    echo "socket couldn't be opened";
?>
```

22 Application examples

22.1 Backup/Restore of data-blocks of S5/S7-PLC

22.1.1 Connection of the device

The EtherSens is supplied with voltage (24V DC +/-20%) via the clamping connections.

Please note that a USB-Stick or SD card is required for a backup of a data block.

22.1.2 Using a digital IO trigger

When you want to use a digital IO as a trigger for backing up or restoring a data block you will have to connect the appropriate signal to the device.

Important: By default only the digital IOs with odd numbers (1, 3, 5, 7, 9, 11) are configured as inputs. The trigger signal must be connected to inputs only!

22.1.3 Access to the device

The access to device can be done via WLAN (SSID "EtherSens WiFi" - IP address 192.168.1.58) or via LAN (IP address 192.168.1.59).

Please open the web interface of the device and log in on the device via the menu item "log in" (without a password), so you can start the configuration.

Important: Please make sure that before you start with the further configuration the network and WLAN parameters fits to your network and PLC. You can change this parameters on the menu item "system" → "network and WiFi".

>> *Further information about the respective configurations parameters can be found in the chapter "Web server".*

22.1.4 Enabling the USB connector

If you want to store the backup of the data block on a USB-Stick you will first have to enable the USB connector. For this please navigate to the page “System” → “USB” and select the operation mode “use LTE module and USB storage stick on EtherSens” and save this setting.

22.1.5 Create PLC connection

On the EtherSens you will first have to create the connection to the PLC. For this please navigate to the page “process” → “devices” and fill in the last line of the table as follows:

name: *freely selectable*
interface: RFC1006
network interface: interface where the controller is connected to
IP address: *see table*
rack: *default value see table*
slot: *default value see table*

controller type and access type	needed hardware	IP address	rack	slot
S7-200 via PPI	S7-LAN	IP from S7-LAN	0	2
S7-300/400 via MPI/DP	S7-LAN	IP from S7-LAN	0	2
S7-300/400 via Ethernet-CP	-	IP from PLC	0	2
S7-1200/1500 via Ethernet	-	IP from PLC	0	1
LOGO! via Ethernet	-	IP from PLC	0	1
S5 via PG port	S5-LAN++	IP from S5-LAN++	0	2

Next you have to click on the + symbol to add the entry and finally on the “save” button.

22.1.6 Create PLC trigger

If you want to control the backup action of a data block via the PLC you will have to add a trigger value on the device. For this please navigate to the page “process” → “process values” and fill in the last line of the table:

sampling rate:	1 second (<i>higher or lower as needed</i>)
name:	<i>freely selectable</i>
chart color:	-
change checking:	not set
record:	not set
view web:	set (<i>optional</i>)

Afterwards you have to click on the + symbol to add the entry. Now a dialog should be opened where you can select the previously created PLC connection as a device. As soon as you have confirmed this dialog another dialog with some further parameters will be shown:

register:	trigger bit from PLC (<i>z. B. M120.4</i>)
format:	bool
sign:	not set
type:	read
power fail value:	not set

Finally you have to click on the “Save” button.

If you also want to control the restore action via the PLC you will have to create a second trigger value. The steps are the same as described above.

22.1.7 Create Backup/Restore block

In the next step you will have to define the data block which should be backed up and restored from the device. Please navigate to the page “process” → “DB backup/restore” and fill in the last line of the table:

en.:	set
name:	<i>freely selectable</i>
PLC:	previously created PLC connection

number:	number of the data block
offset:	byte offset of the data which should be backed up from the data block
length:	length of the data which should be backed up from the data block
storage place:	storage place for the backup of the data block

Next you have to click on the + symbol to add the entry and finally on the “save” button.

22.1.8 Create backup/restore action

In the last step you will have to configure the link between the trigger and the backup/restore. Please navigate to the page “process” → “limit values”. For the action to save the data block you will have to fill in the last line of the table as follows:

en:	set
value:	previously created PLC trigger or digital input
limit type:	==
limit value:	x1
action type:	counter
action counter:	0
action:	backup DB
action value:	previously created backup/restore entry
ack:	-

Next you have to click on the + symbol to add the entry and finally on the “save” button.

With the same procedure as described above you can now also create the action for restoring a data block.

22.2 PLC-controlled sending of messages

22.2.1 Connection of the device

The EtherSens is supplied with voltage (24V DC +/-20%) via the clamping connections.

22.2.2 Access to the device

The access to device can be done via WLAN (SSID "EtherSens WiFi" - IP address 192.168.1.58) or via LAN (IP address 192.168.1.59).

Please open the web interface of the device and log in on the device via the menu item "log in" (without a password), so you can start the configuration.

Important: Please make sure that before you start with the further configuration the network and WLAN parameters fits to your network and PLC. You can change this parameters on the menu item "system" → "network and WiFi".

>> *Further information about the respective configurations parameters can be found in the chapter "Web server".*

22.2.3 Configure SMS service

For sending SMS messages you will first have to configure the LTE modem. For this please navigate to the page "system" → "USB" and select the operation mode "use LTE module and USB storage stick on EtherSens". Afterwards you will have to configure the parameters within the block "LTE module":

SIM pin:	pin code of you SIM card
access point name (APN):	APN from your provider (<i>by default „internet“</i>)
username:	username for your provider (<i>empty by default</i>)
password:	password for you provider (<i>empty by default</i>)
SMS limit monitor:	set

SMS PLC message: not set
SMS receiver: telephone number of the SMS receiver

Finally you have to click on the “save” button to submit the settings.

22.2.4 Configure mailing

For sending e-mails you will first have to define the SMTP server for sending mails within your device. For this please navigate to the page “system” → “e-mail”. There you will have to enable the option “limit monitor”. Afterwards you will need to define the parameters from your SMTP server. If needed you may want to contact your mail provider for the correct settings. Finally you have to click on the “save” button to submit the settings.

If you would like you can now also test the mailing by clicking on the button “send e-mail”.

22.2.5 Create PLC connection

On the EtherSens you will first have to create the connection to the PLC. Please navigate to the page “process” → “devices” and fill in the last line of the table as follows:

name: *freely selectable*
interface: RFC1006
network interface: interface where the controller is connected to
IP address: *see table*
rack: *default value see table*
slot: *default value see table*

controller type and access type	needed hardware	IP address	rack	slot
S7-200 via PPI	S7-LAN	IP from S7-LAN	0	2
S7-300/400 via MPI/DP	S7-LAN	IP from S7-LAN	0	2
S7-300/400 via Ethernet-CP	-	IP from PLC	0	2

S7-1200/1500 via Ethernet	-	IP from PLC	0	1
LOGO! via Ethernet	-	IP from PLC	0	1
S5 via PG port	S5-LAN++	IP from S5-LAN++	0	2

Next you have to click on the + symbol to add the entry and finally on the “save” button.

22.2.6 Create PLC value

If you want to send a SMS or e-mail depending on a bit or value from your PLC, you will have to create this value on your device. For this please navigate to the page “process” → “process values” and fill in the last line of the table:

sampling rate: 1 second (*higher or lower as needed*)
name: *freely selectable*
chart color: -
change checking: not set
recording: not set
view web: *set (optional)*

Afterwards you have to click on the + symbol to add the entry. Now a dialog should be opened where you can select the previously created PLC connection as a device. As soon as you have confirmed this dialog another dialog with some further parameters will be shown:

register: Trigger-Bit/value from PLC (*e. g. M120.4 or DB10.DBD24*)
format: *freely selectable*
sign: *depends on value*
type: read
power fail value: not set

Finally you have to click on the “Save” button.

If you want to retrieve multiple bits or values from your PLC, you will just need to repeat the steps above as often as needed.

22.2.7 Create message

In the last step you will have to define the actual event, when a SMS or e-mail should be sent and define the desired message. For this navigate to the page “process” → “limit values” and fill in the last line of the table as follows:

en:	set
value:	previously created PLC value
limit type:	<i>freely selectable</i>
limit value:	<i>freely selectable (short cut d for decimal, x for hexadecimal or f for floating point have to be preceded to the value, e. g. d120 or f35.7)</i>
action type:	counter
action counter:	0
action:	SMS or e-mail
action value:	default message or individual message
ack:	not set

If you would like to define an own individual message with an own text and / or recipient you have to click on the text “default message”. Through this a new window will be opened where you can create a individual message. After you have created the message you will just have to assign this message to the limit value.

Important: For the storage of individual messages a SD card have to be plugged in on the device.

Next you have to click on the + symbol to add the entry and finally on the “save” button.

With the same procedure as described above you can now configure multiple messages with different values or different recipients.

22.2.8 Using messages from PLC

Additionally to the messages which can be stored within the device itself the EtherSens can also be used to sent messages directly from the PLC. The description of the therefore needed configuration as well as the preparation in the controller can be found within the manual of the EtherSens devices in the chapter “PLC controlled e-mail and SMS delivery”.

22.3 Processing process values in the control

22.3.1 Connection of the device

The EtherSens gets directly supplied from the Line L1 with voltage (100-240V AC 50-60 Hz) via the clamping connections. If you also want to do current and power measurements you will also have to connect the Rogowski coils with the device.

22.3.2 Access to the device

The access to device can be done via WLAN (SSID "EtherSens WiFi" - IP address 192.168.1.58) or via LAN (IP address 192.168.1.59).

Please open the web interface of the device and log in on the device via the menu item "log in" (without a password), so you can start the configuration.

Important: Please make sure that before you start with the further configuration the network and WLAN parameters fits to your network and PLC. You can change this parameters on the menu item "system" → "network and WiFi".

>> *Further information about the respective configurations parameters can be found in the chapter "Web server".*

22.3.3 Create PLC connection

On the EtherSens you will first have to create the connection to the PLC. Please navigate to the page "process" → "devices" and fill in the last line of the table as follows:

name:	<i>freely selectable</i>
interface:	RFC1006
network interface:	interface where the controller is connected to
IP address:	<i>see table</i>
rack:	<i>default value see table</i>
slot:	<i>default value see table</i>

controller type and access type	needed hardware	IP address	rack	slot
S7-200 via PPI	S7-LAN	IP from S7-LAN	0	2
S7-300/400 via MPI/DP	S7-LAN	IP from S7-LAN	0	2
S7-300/400 via Ethernet-CP	-	IP from PLC	0	2
S7-1200/1500 via Ethernet	-	IP from PLC	0	1
LOGO! via Ethernet	-	IP from PLC	0	1
S5 via PG port	S5-LAN++	IP from S5-LAN++	0	2

Next you have to click on the + symbol to add the entry and finally on the “save” button.

22.3.4 Create PLC value

If you now want to transfer a process value from your EtherSens (e. g. a voltage or current value) to you PLC, you will first have to create a new process value. For this please navigate to the page “process” → “process value” and fill in the last line of the table:

sampling rate: 1 second (*higher or lower as needed*)
name: *freely selectable*
chart color: -
change checking: not set
record: not set
view web: not set

Afterwards you have to click on the + symbol to add the entry. Now a dialog should be opened where you can select the previously created PLC connection as a device. As soon as you have confirmed this dialog another dialog with some further parameters will be shown:

register:	target value in the PLC (e. g. DB10.DBD24)
format:	float
sign:	not set
type:	write
power fail value:	not set

Important: The here used format “float” is equivalent to the S7 format REAL. If you want to use the S7 format DINT for integers you will need to select the format “decimal” above.

Finally you have to click on the “Save” button.

If you want to transfer multiple values from your EtherSens to your PLC, you will just need to repeat the steps above as often as needed.

22.3.5 Link PLC value to process value

In the last step you will have to link the newly created PLC value to the process value. For this please swap to the page “process” → “calculations” and search for your created PLC value. In this line you will now have to select “=” as “type 1” and enter the name of the process value within the field “value 1“, which you want to link to, with a preceded @ sign (e. g. “@Voltage L1 (rms)”). Afterwards you will have to confirm your changes by clicking on the button “save”.